

Automation Panel 1000 - Hygienic design

User's manual

Version: **1.60 (June 2018)**
Model no.: **MAAP1000.HY-ENG**

All values in this manual are current as of its publication. We reserve the right to change the contents of this manual without notice. B&R Industrial Automation GmbH is not liable for technical/editorial errors or incomplete information in this manual. In addition, B&R Industrial Automation GmbH shall not be liable for incidental or consequential damages in connection with or arising from the furnishing, performance or use of this material. We point out that the software and hardware names and brand names of the respective companies used in this document are subject to general trademark, brand or patent protection.

Publishing information

B&R Industrial Automation GmbH

B&R Strasse 1

5142 Eggelsberg

Austria

Telephone: +43 7748 6586-0

Fax: +43 7748 6586-26

office@br-automation.com

The place of jurisdiction, in accordance with article 17 of the European Convention on Courts of Jurisdiction and Enforcement, is A-4910

Ried im Innkreis, Austria, commercial register court: Ried im Innkreis, Austria

Commercial register number: FN 111651 v.

The place of fulfillment in accordance with article 5 of the European Convention on Courts of Jurisdiction and Enforcement is A-5142 Eggelsberg, Austria

Austrian DVR no.: 0721301

VATIN: ATU62367156

1: General information

2: Technical data

3: Commissioning

4: Software

5: Standards and certifications

6: Accessories

7: Servicing and maintenance

Appendix A

1	General information.....	8
1.1	Manual history.....	8
1.2	Safety guidelines.....	9
1.2.1	Intended use.....	9
1.2.2	Protection against electrostatic discharge.....	9
1.2.2.1	Packaging.....	9
1.2.2.2	Guidelines for proper ESD handling.....	9
1.2.3	Policies and procedures.....	9
1.2.4	Transport and storage.....	10
1.2.5	Installation.....	10
1.2.6	Operation.....	10
1.2.6.1	Protection against touching electrical parts.....	10
1.2.6.2	Environmental conditions - Dust, moisture, corrosive gases.....	10
1.2.6.3	Viruses and dangerous programs.....	11
1.2.7	Environmentally friendly disposal.....	11
1.2.7.1	Separation of materials.....	11
1.2.8	Security concept.....	11
1.2.9	Third-party software updates.....	11
1.2.10	Administrator accounts.....	11
1.3	Organization of notices.....	12
1.4	Guidelines.....	12
1.5	Overview.....	13
2	Technical data.....	15
2.1	Introduction.....	15
2.1.1	About this user's manual.....	15
2.1.2	Description of individual modules.....	15
2.1.2.1	AP1000 panels.....	15
2.1.2.2	Link modules.....	15
2.1.3	System components / Configuration.....	16
2.1.3.1	Configuration.....	16
2.2	Complete system.....	16
2.2.1	Connection options.....	16
2.2.1.1	SDL operation.....	17
2.2.1.2	DVI operation.....	18
2.2.1.3	SDL3 mode.....	19
2.2.1.4	SDL4 operation.....	20
2.2.2	Mechanical properties.....	21
2.2.2.1	Installation diagrams.....	21
2.2.2.2	Spacing for air circulation.....	21
2.2.2.3	Mounting orientations.....	23
2.2.2.4	Weight specifications.....	24
2.2.3	Environmental characteristics.....	25
2.2.3.1	Temperature specifications.....	25
2.2.3.2	Humidity.....	29
2.2.3.3	Vibration.....	29
2.2.3.4	Shock.....	29
2.2.3.5	Protection.....	29
2.2.4	Electrical characteristics.....	30
2.2.4.1	+24 VDC power supply.....	30
2.2.4.2	Power calculation.....	30
2.2.4.3	Block diagrams.....	31
2.2.5	SDL/DVI receiver - 5DLSDL.1001-00 device interfaces.....	31
2.2.5.1	Overview.....	31
2.2.5.2	+24 VDC power supply.....	33
2.2.5.3	Panel In interface.....	34
2.2.5.4	USB interfaces.....	36

2.2.5.5 USB In interface.....	37
2.2.5.6 COM serial interface.....	37
2.2.5.7 Brightness controls.....	37
2.2.6 5DLSD3.1001-00 SDL3 receiver - Device interfaces.....	37
2.2.6.1 Overview.....	37
2.2.6.2 +24 VDC power supply.....	39
2.2.6.3 Grounding.....	39
2.2.6.4 SDL3 In interface.....	40
2.2.6.5 SDL3 In LEDs.....	40
2.2.6.6 USB interfaces.....	41
2.2.7 5DLSD4.1001-00 SDL4 receiver - Device interfaces.....	42
2.2.7.1 Overview.....	42
2.2.7.2 +24 VDC power supply.....	43
2.2.7.3 SDL4 In interface.....	44
2.2.7.4 SDL4 In LEDs.....	44
2.2.7.5 USB interfaces.....	45
2.2.8 Features of AP1000 panels.....	45
2.2.8.1 RFID read/write unit.....	46
2.3 Individual components.....	47
2.3.1 Panels.....	47
2.3.1.1 5AP1120.0702-I00.....	47
2.3.1.2 5AP1125.1043-I00.....	49
2.3.1.3 5AP1125.1044-I00.....	51
2.3.1.4 5AP1125.1505-I00.....	53
2.3.2 Link modules.....	55
2.3.2.1 5DLSDL.1001-00.....	55
2.3.2.2 5DLSD3.1001-00.....	57
2.3.2.3 5DLSD4.1001-00.....	59
3 Commissioning.....	60
3.1 Installation.....	60
3.1.1 Important information concerning installation/commissioning.....	60
3.1.2 Mounting an Automation Panel 1000 with retaining clips.....	61
3.1.3 Replacing link modules.....	64
3.2 Connecting to the power grid.....	65
3.2.1 Installing the DC power cable.....	65
3.2.1.1 Wiring.....	65
3.2.2 Connecting the power supply to a B&R device.....	66
3.2.3 Functional ground - Grounding concept.....	67
3.3 Cable connections.....	68
3.4 Switching on the device for the first time.....	69
3.4.1 General information before switching on the device.....	69
3.4.2 Switching on the Automation Panel.....	69
3.5 Touch screen calibration.....	70
3.5.1 Single-touch (analog resistive).....	70
3.5.1.1 Windows Embedded 8.1 Industry Pro.....	70
3.5.1.2 Windows 7 Professional / Ultimate.....	70
3.5.1.3 Windows Embedded Standard 7 Embedded / Premium.....	70
3.5.1.4 Windows XP Professional.....	70
3.5.1.5 Windows Embedded Standard 2009.....	70
3.6 Adjusting the display brightness.....	71
3.6.1 Adjusting in SDL / SDL3 / SDL4 mode.....	71
3.6.2 Adjusting in DVI mode.....	71
4 Software.....	72
4.1 Upgrade information.....	72
4.1.1 Upgrading the firmware on the Automation Panel.....	72

4.2 B&R Automation Device Interface (ADI) Control Center.....	72
4.2.1 Functions.....	73
4.2.2 Installation.....	73
4.3 B&R Automation Device Interface (ADI) Development Kit.....	74
4.4 B&R Automation Device Interface (ADI) .NET SDK.....	75
5 Standards and certifications.....	76
5.1 Standards and guidelines.....	76
5.1.1 CE marking.....	76
5.1.2 EMC directive.....	76
5.1.3 Low voltage directive.....	76
5.2 Certifications.....	77
5.2.1 UL certification.....	77
6 Accessories.....	78
6.1 Power connectors.....	78
6.1.1 OTB103.9x.....	78
6.1.1.1 General information.....	78
6.1.1.2 Order data.....	78
6.1.1.3 Technical data.....	78
6.2 USB flash drives.....	80
6.2.1 5MMUSB.xxxx-01.....	80
6.2.1.1 General information.....	80
6.2.1.2 Order data.....	80
6.2.1.3 Technical data.....	80
6.2.1.4 Temperature/Humidity diagram.....	81
6.2.2 5MMUSB.032G-02.....	82
6.2.2.1 General information.....	82
6.2.2.2 Order data.....	82
6.2.2.3 Technical data.....	82
6.2.2.4 Temperature/Humidity diagram.....	83
6.3 Cables.....	84
6.3.1 DVI cables.....	84
6.3.1.1 5CADVI.0xxx-00.....	84
6.3.2 SDL cables.....	87
6.3.2.1 5CASDL.0xxx-00.....	87
6.3.3 SDL cables with 45° male connector.....	90
6.3.3.1 5CASDL.0xxx-01.....	90
6.3.4 SDL flex cables.....	93
6.3.4.1 5CASDL.0xxx-03.....	93
6.3.5 SDL flex cables with extender.....	97
6.3.5.1 5CASDL.0xx0-13.....	97
6.3.6 SDL3/SDL4 cables.....	101
6.3.6.1 5CASD3.xxxx-00.....	101
6.3.7 USB cables.....	104
6.3.7.1 5CAUSB.00xx-00.....	104
6.3.8 RS232 cables.....	106
6.3.8.1 9A0014.xx.....	106
7 Servicing and maintenance.....	108
7.1 Cleaning.....	108
7.2 Tips for extending the service life of the display.....	109
7.2.1 Backlight.....	109
7.2.1.1 How can the service life of backlights be extended?.....	109
7.2.2 Image persistence.....	109
7.2.2.1 What causes image persistence?.....	109
7.2.2.2 How can image persistence be reduced?.....	109

7.3 Pixel errors.....	109
Appendix A	110
A.1 Abbreviations.....	110
A.2 Viewing angles.....	110
A.3 Chemical resistance.....	111
A.3.1 Autotex panel overlay (polyester).....	111

1 General information

Information:

This user's manual is not intended for end customers! It is the responsibility of the machine manufacturer or system provider to provide the safety guidelines relevant to end customers in the operating instructions for the end customer in the respective local language.

1.1 Manual history

Version	Date	Change
1.00	2015-08-13	<ul style="list-style-type: none">• First version
1.10	2016-04-08	<ul style="list-style-type: none">• Adding the temperature data
1.20	2016-12-05	<ul style="list-style-type: none">• Chapter 3: Changed mounting an Automation Panel 1000 with retaining clips.
1.30	2017-05-08	<ul style="list-style-type: none">• Updated user's manual.
1.40	2017-11-13	Updated book. <ul style="list-style-type: none">• Updated chapter "Individual components".
1.50	2018-01-17	Updated book. <ul style="list-style-type: none">• Updated chapter "Electrical characteristics".• Updated chapter "Standards and certifications".
1.60	2018-06-18	Updated book. <ul style="list-style-type: none">• Added UL certification.• Added SDL4.

1.2 Safety guidelines

1.2.1 Intended use

Programmable logic controllers (PLCs), operating/monitoring devices (industrial PCs, Power Panels, Mobile Panels, etc.) and uninterruptible power supplies from B&R have been designed, developed and manufactured for conventional use in industrial environments. They were not designed, developed and manufactured for any use involving serious risks or hazards that could lead to death, injury, serious physical impairment or loss of any kind without the implementation of exceptionally stringent safety precautions. In particular, this includes the use of these devices to monitor nuclear reactions in nuclear power plants, in flight control or flight safety systems as well as in the control of mass transportation systems, medical life support systems or weapons systems.

1.2.2 Protection against electrostatic discharge

Electrical components that can be damaged by electrostatic discharge (ESD) must be handled accordingly.

1.2.2.1 Packaging

- **Electrical components with a housing**
...do not require special ESD packaging but must be handled properly (see "Electrical components with a housing").
- **Electrical components without a housing**
...are protected by ESD-suitable packaging.

1.2.2.2 Guidelines for proper ESD handling

Electrical components with a housing

- Do not touch the connector contacts on connected cables.
- Do not touch the contact tips on circuit boards.

Electrical components without a housing

The following points apply in addition to the points listed under "Electrical components with a housing":

- Any persons handling electrical components or devices with installed electrical components must be grounded.
- Components are only permitted to be touched on their narrow sides or front plate.
- Components must always be placed on or stored in a suitable medium (ESD packaging, conductive foam, etc.). Metallic surfaces are not suitable storage surfaces!
- Components must not be subjected to electrostatic discharge (e.g. caused by charged plastics).
- Observe a minimum distance of 10 cm from monitors and television sets.
- Measuring instruments and equipment must be grounded.
- Probe tips of galvanically isolated measuring instruments must be temporarily discharged on suitably grounded surfaces before taking measurements.

Individual components

- ESD protective measures for individual components are thoroughly implemented at B&R (conductive floors, footwear, arm bands, etc.).
- Increased ESD protective measures for individual components are not required for handling B&R products at customer locations.

1.2.3 Policies and procedures

Electronic devices are never completely failsafe. If the programmable logic controller, operating/monitoring device or uninterruptible power supply fails, the user is responsible for ensuring that other connected devices such as motors are brought to a safe state.

When using programmable logic controllers or operating/monitoring devices as control systems in connection with a Soft PLC (e.g. B&R Automation Runtime or comparable product) or Slot PLC (e.g. B&R LS251 or comparable product), safety precautions relevant to industrial control systems (e.g. the provision of safety devices such as emergency stop, etc.) must be observed in accordance with applicable national and international regulations. This also applies to all other devices connected to the system, such as drives.

All tasks such as the installation, commissioning and servicing of devices are only permitted to be carried out by qualified personnel. Qualified personnel are those familiar with the transport, mounting, installation, commissioning and operation of devices who also have the appropriate qualifications to perform these tasks (e.g. IEC 60364). National accident prevention regulations must be observed.

The safety notices, information about connection conditions (nameplate and documentation) and limit values specified in the technical data must be read carefully before installation and commissioning and are to be observed in all cases.

1.2.4 Transport and storage

During transport and storage, devices must be protected against undue stress (mechanical loads, temperature, moisture, corrosive atmospheres, etc.).

1.2.5 Installation

- Devices are not ready for use immediately upon delivery. They must be installed and wired according to the requirements of this documentation in order for EMC limit values to be observed.
- Installation must be performed according to this documentation using suitable equipment and tools.
- Devices are only permitted to be installed by qualified personnel and when the power is switched off. Before installation, voltage to the control cabinet must be switched off and prevented from being switched on again.
- General safety guidelines and national accident prevention regulations must be observed.
- Electrical installation must be carried out in accordance with applicable guidelines (e.g. wire cross sections, fuses, protective ground connections).

1.2.6 Operation

1.2.6.1 Protection against touching electrical parts

To operate programmable logic controllers, operating/monitoring devices and uninterruptible power supplies, certain components must carry dangerous voltage levels over 42 VDC. Touching one of these components can result in a life-threatening electric shock. This could lead to death, severe injury or damage to property.

Before switching on programmable logic controllers, operating/monitoring devices or the uninterruptible power supply, it must be ensured that the housing is properly connected to ground (PE rail). Ground connections must also be established when the operating/monitoring device or uninterruptible power supply is connected for test purposes or only being operated for a short period of time!

Before switching on the device, all voltage-carrying components must be securely covered. During operation, all covers must remain closed.

1.2.6.2 Environmental conditions - Dust, moisture, corrosive gases

The use of operating/monitoring devices (e.g. industrial PCs, Power Panels, Mobile Panels) and uninterruptible power supplies in very dusty environments must be avoided. The collection of dust on devices can affect functionality and may prevent sufficient cooling, especially in systems with active cooling (fans).

The presence of corrosive gases can also result in impaired functionality. In combination with high temperature and humidity, corrosive gases – e.g. with sulfur, nitrogen and chlorine components – can induce chemical reactions that can damage electronic components very quickly. The presence of corrosive gases is indicated by blackened copper surfaces and cable ends on existing installations.

When operated in dusty or moist environments that could potentially impair functionality, operating/monitoring devices such as the Automation Panel and Power Panel are protected on the front against the ingress of dust or moisture when installed properly (e.g. cutout installation). The back of all devices must be protected from the ingress of dust and moisture, however; any collected dust must be removed at suitable intervals.

1.2.6.3 Viruses and dangerous programs

This system is subject to potential risk each time data is exchanged or software is installed from a data storage device (e.g. diskette, CD-ROM, USB flash drive, etc.), network connection or the Internet. The user is responsible for assessing these risks, implementing preventive measures such as virus protection programs, firewalls, etc. and making sure that software is obtained only from trusted sources.

1.2.7 Environmentally friendly disposal

All programmable controllers, operating/monitoring devices and uninterruptible power supplies from B&R are designed to minimize harm to the environment as far as possible.

1.2.7.1 Separation of materials

It is necessary to separate out the different materials so that devices can undergo an environmentally friendly recycling process.

Component	Disposal
Programmable logic controllers Operating/Monitoring devices Uninterruptible power supply Batteries and rechargeable batteries Cables	Electronics recycling
Cardboard/Paper packaging	Paper/Cardboard recycling
Plastic packaging material	Plastic recycling

Table 1: Environmentally friendly disposal

Disposal must take place in accordance with applicable legal regulations.

1.2.8 Security concept

To protect plants, systems, machines and networks against cyber threats, it is necessary to implement (and continuously maintain) an integrated security concept that is state of the art. B&R products and solutions form only one part of such a concept.

The user is responsible for preventing unauthorized access to his plants, systems, machines and networks. Systems, machines and components should only be connected to the corporate network or Internet if and to the extent necessary and appropriate protective measures (e.g. use of firewalls and network segmentation) have been taken.

B&R products and solutions are constantly being developed further to make them even more secure. B&R strongly recommends that updates be performed as soon as the corresponding updates are available and that only the latest product versions are used. Using outdated or unsupported versions can increase the risk of cyber threats.

1.2.9 Third-party software updates

This product contains third-party software (e.g. drivers, etc.). B&R only assumes warranty for updates/patches to the third-party software if they have been officially released by B&R. Otherwise, updates/patches are undertaken at your own risk.

1.2.10 Administrator accounts

A user with administrator rights has extensive access and manipulation options available on the system.

Therefore, make sure that your administrator accounts are adequately secured to prevent unauthorized changes. Use secure passwords and a standard user account for regular operation. Further measures such as the use of security guidelines are to be applied as needed.

1.3 Organization of notices

Safety notices

Contain **only** information that warns of dangerous functions or situations.

Signal word	Description
Danger!	Failure to observe these safety guidelines and notices will result in death, severe injury or substantial damage to property.
Warning!	Failure to observe these safety guidelines and notices can result in death, severe injury or substantial damage to property.
Caution!	Failure to observe these safety guidelines and notices can result in minor injury or damage to property.
Notice!	Failure to observe these safety guidelines and notices can result in damage to property.

Table 2: Organization of safety notices

General notices

Contain **useful** information for users and instructions for avoiding malfunctions.

Signal word	Description
Information:	Useful information, application tips and instructions for avoiding malfunctions.

Table 3: Organization of general notices

1.4 Guidelines

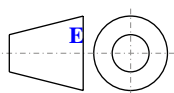

European dimension standards apply to all dimension diagrams.

All dimensions are specified in mm.

Unless otherwise specified, the following general tolerances apply:

Range of nominal size	General tolerance per DIN ISO 2768 (medium)
Up to 6 mm	±0.1 mm
6 to 30 mm	±0.2 mm
30 to 120 mm	±0.3 mm
120 to 400 mm	±0.5 mm
400 to 1000 mm	±0.8 mm

Table 4: Range of nominal sizes

1.5 Overview

Model number	Short description	Page
Accessories		
0TB103.9	Connector 24 VDC - 3-pin female - Screw clamp terminal block 3.31 mm ²	78
0TB103.91	Connector 24 VDC - 3-pin female - Cage clamp terminal block 3.31 mm ²	78
DVI cables		
5CADVI.0018-00	DVI-D cable - 1.8 m	84
5CADVI.0050-00	DVI-D cable - 5 m	84
5CADVI.0100-00	DVI-D cable - 10 m	84
Link modules		
5DLS3.1001-00	Automation Panel link module - SDL3 receiver - For Automation Panel 923/933/1000 - For Automation Panel 5000	57
5DLS4.1001-00	Automation Panel link module - SDL4 receiver - For Automation Panel 923/933/1000 - For Automation Panel 5000	59
5DLS4.1001-00	Automation Panel link module - SDL/DVI receiver - For Automation Panel 923/933/1000 - For Automation Panel 5000	55
Panels		
5AP1120.0702-100	- Automation Panel 7.0" WVGA TFT - 800 x 480 pixels (16:10) - Single-touch (resistive), with fully integrated touch screen, without dirt-collecting edge - Non-rusting stainless steel front - Control cabinet installation - Landscape format - For PPC2100/PPC2200 - For link modules - Compatible with 5PP520.0702-B00	47
5AP1125.1043-100	- Automation Panel 10.4" VGA TFT - 640 x 480 pixels (4:3) - Single-touch (analog resistive), with fully integrated touch screen, without dirt-collecting edge - Non-rusting stainless steel front - Control cabinet installation - Landscape format - 13.56 MHz read/write transponder unit - For PPC900/PPC2100/PPC3100/PPC2200 - For link modules - Compatible with 5PP520.1043-B00/5PP520.1043-B10	49
5AP1125.1044-100	- Automation Panel 10.4" SVGA TFT - 800 x 600 pixels (4:3) - Single-touch (analog resistive), with fully integrated touch screen, without dirt-collecting edge - Non-rusting stainless steel front - Control cabinet installation - Landscape format - 13.56 MHz read/write transponder unit - For PPC900/PPC2100/PPC3100/PPC2200 - For link modules - Compatible with 5PP520.1043-B00/5PP520.1043-B10	51
5AP1125.1505-100	- Automation Panel 15.0" XGA TFT - 1024 x 768 pixels (4:3) - Single-touch (analog resistive), with fully integrated touch screen, without dirt-collecting edge - Non-rusting stainless steel front - Control cabinet installation - Landscape format - 13.56 MHz read/write transponder unit - For PPC900/PPC2100/PPC3100/PPC2200 - For link modules - Compatible with 5PP520.1505-B00/5PP520.1505-B10	53
RS232 cables		
9A0014.02	RS232 extension cable for operation of a remote display unit with touch screen, 1.8 m	106
9A0014.05	RS232 extension cable for operation of a remote display unit with touch screen, 5 m	106
9A0014.10	RS232 extension cable for operation of a remote display unit with touch screen, 10 m	106
SDL cables		
5CASDL.0008-00	SDL cable - 0.8 m	87
5CASDL.0018-00	SDL cable - 1.8 m	87
5CASDL.0050-00	SDL cable - 5 m	87
5CASDL.0100-00	SDL cable - 10 m	87
5CASDL.0150-00	SDL cable - 15 m	87
5CASDL.0200-00	SDL cable - 20 m	87
5CASDL.0250-00	SDL cable - 25 m	87
5CASDL.0300-00	SDL cable - 30 m	87
SDL cables 45° connection		
5CASDL.0018-01	SDL cable - 45 degree connector - 1.8 m	90
5CASDL.0050-01	SDL cable - 45 degree connector - 5 m	90
5CASDL.0100-01	SDL cable - 45 degree connector - 10 m	90
5CASDL.0150-01	SDL cable - 45 degree connector - 15 m	90
SDL cables flex		
5CASDL.0018-03	SDL flex cable - 1.8 m	93
5CASDL.0050-03	SDL flex cable - 5 m	93
5CASDL.0100-03	SDL flex cable - 10 m	93
5CASDL.0150-03	SDL flex cable - 15 m	93
5CASDL.0200-03	SDL flex cable - 20 m	93
5CASDL.0250-03	SDL flex cable - 25 m	93
5CASDL.0300-03	SDL flex cable - 30 m	93
5CASDL.0300-13	SDL flex cable with extender - 30 m	97
5CASDL.0400-13	SDL flex cable with extender - 40 m	97
5CASDL.0430-13	SDL flex cable with extender - 43 m	97
SDL3/SDL4 cables		
5CASD3.0030-00	SDL3/SDL4 cable - 3 m	101
5CASD3.0050-00	SDL3/SDL4 cable - 5 m	101
5CASD3.0100-00	SDL3/SDL4 cable - 10 m	101
5CASD3.0150-00	SDL3/SDL4 cable - 15 m	101
5CASD3.0200-00	SDL3/SDL4 cable - 20 m	101
5CASD3.0300-00	SDL3/SDL4 cable - 30 m	101
5CASD3.0500-00	SDL3/SDL4 cable - 50 m	101
5CASD3.1000-00	SDL3/SDL4 cable - 100 m	101
USB accessories		
5MMUSB.032G-02	USB 3.0 flash drive 32 GB MLC	82
5MMUSB.2048-01	USB 2.0 flash drive 2048 MB B&R	80
5MMUSB.4096-01	USB 2.0 flash drive 4096 MB B&R	80
USB cables		
5CAUSB.0018-00	USB 2.0 connection cable - Type A - type B connector - 1.8 m	104

General information

Model number	Short description	Page
5CAUSB.0050-00	USB 2.0 connection cable - Type A - type B connector - 5 m	104

2 Technical data

2.1 Introduction

2.1.1 About this user's manual

This user's manual contains all relevant information about an operational Automation Panel 1000 cabinet-mounted device.

This user's manual applies to the modular Automation Panel 1000 product generation. Information about Automation Panel 920, 980, 981 and 982 systems can be found in the Automation Panel 900 user's manual. Information about Automation Panel 9x3 systems can be found in the Automation Panel 9x3 user's manual.

2.1.2 Description of individual modules

2.1.2.1 AP1000 panels

AP1000 panels form the basis for the Automation Panel 1000, Panel PC 900, Panel PC 2100, Panel PC 2200 and Panel PC 3100 system families. A wide selection of different display diagonals as well as panels with touch screen and RFID are available. The panels can only be operated as a complete system in combination with a link module (Automation Panel 1000) or CPU board and system unit (Panel PC 900, Panel PC 2100, Panel PC 2200, Panel PC 3100).



2.1.2.2 Link modules

Link modules have various graphics interfaces and connections. An Automation Panel is put together by installing a link module onto a panel.

A link module cannot be operated without a panel.







2.1.3 System components / Configuration

Automation Panel 1000, Panel PC 900, Panel PC 2100 and Panel PC 3100 systems can be assembled to meet individual requirements and operating conditions. Automation Panel 1000, Panel PC 900, Panel PC 2100 and Panel PC 3100 systems are flexible so that an Automation Panel can be converted to a Panel PC or vice versa.

2.1.3.1 Configuration

The following individual components are required for operation as an Automation Panel 1000:

- Panel
- Link module or system unit
- Terminal block
- Pressure frame

Configuration - Base system																																				
Panels	Select 1																																			
 	<table border="1"> <thead> <tr> <th></th> <th>Diagonal</th> <th>Resolution</th> <th>Touch screen</th> <th>RFID</th> </tr> </thead> <tbody> <tr> <td colspan="5">Automation Panel 1120</td> </tr> <tr> <td>5AP1120.0702-I00</td> <td>7"</td> <td>WVGA</td> <td>Single-touch</td> <td>No</td> </tr> <tr> <td colspan="5">Automation Panel 1125</td> </tr> <tr> <td>5AP1125.1043-I00</td> <td>10.4"</td> <td>VGA</td> <td>Single-touch</td> <td>Yes</td> </tr> <tr> <td>5AP1125.1044-I00</td> <td>10.4"</td> <td>SVGA</td> <td>Single-touch</td> <td>Yes</td> </tr> <tr> <td>5AP1125.1505-I00</td> <td>15"</td> <td>XGA</td> <td>Single-touch</td> <td>Yes</td> </tr> </tbody> </table>		Diagonal	Resolution	Touch screen	RFID	Automation Panel 1120					5AP1120.0702-I00	7"	WVGA	Single-touch	No	Automation Panel 1125					5AP1125.1043-I00	10.4"	VGA	Single-touch	Yes	5AP1125.1044-I00	10.4"	SVGA	Single-touch	Yes	5AP1125.1505-I00	15"	XGA	Single-touch	Yes
		Diagonal	Resolution	Touch screen	RFID																															
	Automation Panel 1120																																			
	5AP1120.0702-I00	7"	WVGA	Single-touch	No																															
	Automation Panel 1125																																			
	5AP1125.1043-I00	10.4"	VGA	Single-touch	Yes																															
	5AP1125.1044-I00	10.4"	SVGA	Single-touch	Yes																															
5AP1125.1505-I00	15"	XGA	Single-touch	Yes																																
Link modules	Select 1																																			
	5DLSDL.1001-00 SDL/DVI receiver 5DLSD3.1001-00 SDL3 receiver 5DLSD4.1001-00 SDL4 receiver																																			
Terminal blocks	Select 1																																			
	Power connectors 0TB103.9 0TB103.91																																			

2.2 Complete system

2.2.1 Connection options

The Automation Panel can be connected to a B&R industrial PC via SDL, DVI SDL3 or SDL4 operations. The connection options described below provide an overview of the operating modes as well as possible limitations.

2.2.1.1 SDL operation

2.2.1.1.1 SDL operation - Mode 1

In SDL operating mode 1, all communication between the Automation Panel and B&R industrial PC is handled using a single SDL cable.

In addition to display data, information from the touch screen and matrix keys as well as service and diagnostic data is transferred. The Automation Panel can be installed up to from the B&R industrial PC. USB 1.1 is also transferred over this distance and fully integrated in SDL. External modules are not necessary for this.

The brightness of the display can be set using the ADI Control Center, for example.

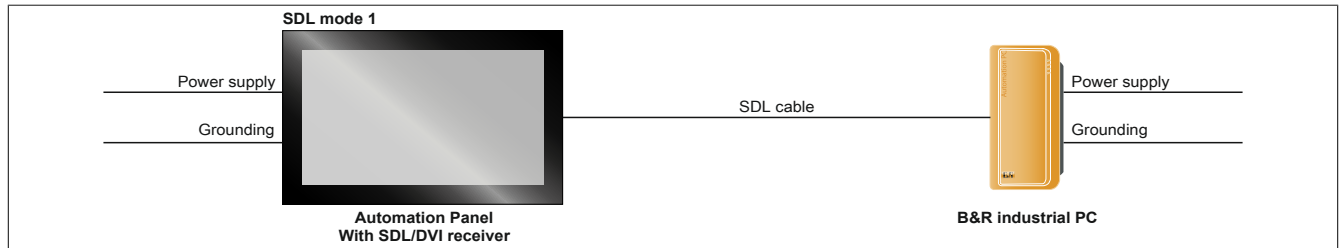

Availability of interfaces on the Automation Panel with SDL/DVI receiver:

Panel In	✓	USB In	✗	Power supply	✓	Brightness controls	✗
USB1, USB2	✓	COM touch screen inter-face	✗	Grounding	✓		

Requirements

- Automation Panel with SDL/DVI receiver
- B&R industrial PC with SDL interface
- SDL cable

2.2.1.1.2 SDL operation - Mode 2

In SDL operating mode 2, communication between the Automation Panel and B&R industrial PC is handled using an SDL cable connected to interface "Panel In" and a USB type A/B cable connected to interface "USB In".

In addition to display data, information from the resistive touch screen and matrix keys as well as LED, service and diagnostic data is transferred over the SDL cable. Data from the multi-touch touch screen is transferred over the USB type A/B cable. The Automation Panel can be installed up to 5 m (USB specification) from the B&R industrial PC. USB 2.0 data can be transferred over this distance via the USB type A/B cable. External modules are not necessary for this.

The brightness of the display can be set using the ADI Control Center, for example.

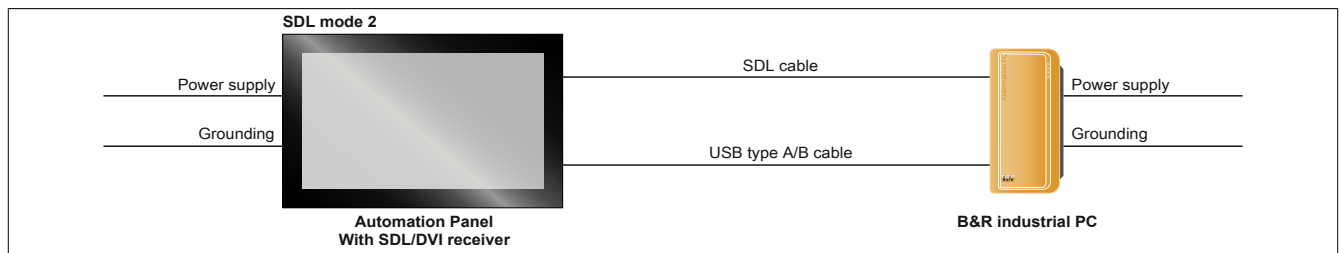

Availability of interfaces on the Automation Panel with SDL/DVI receiver:

Panel In	✓	USB In	✓	Power supply	✓	Brightness controls	✗
USB1, USB2	✓	COM touch screen inter-face	✗	Grounding	✓		

Maximum cable length: 5 m

Requirements

- Automation Panel with SDL/DVI receiver
- B&R industrial PC with SDL interface
- SDL cable, USB type A/B cable

2.2.1.2 DVI operation

In the DVI operating mode, all signals needed to operate the Automation Panel are each transferred over a separate cable. The brightness of the display can be set using the brightness buttons.

2.2.1.2.1 DVI operation with single-touch Automation Panel

If an Automation Panel with resistive touch screen (single-touch) is operated with DVI, then a DVI cable, USB type A/B cable and RS232 cable must be connected.

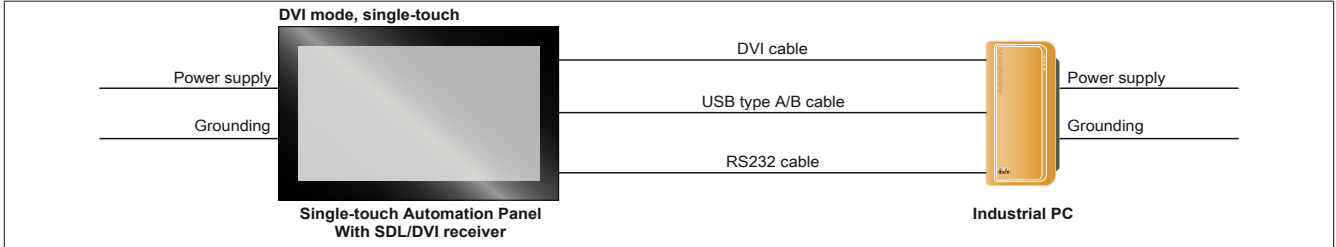

Availability of interfaces on the Automation Panel with SDL/DVI receiver:

Panel In	✓	USB In	✓ USB 2.0	Power supply	✓	Brightness controls	✓
USB1, USB2	✓ USB 2.0	COM touch screen inter-face	✓	Grounding	✓		

Maximum cable length: 5 m

Requirements

- Automation Panel with SDL/DVI receiver
- B&R industrial PC with DVI interface
- DVI cable, USB type A/B cable, RS232 cable

2.2.1.2.2 DVI mode with multi-touch Automation Panel

If an Automation Panel with PCT touch screen (multi-touch) is operated with DVI, then a DVI cable and USB type A/B cable must be connected.

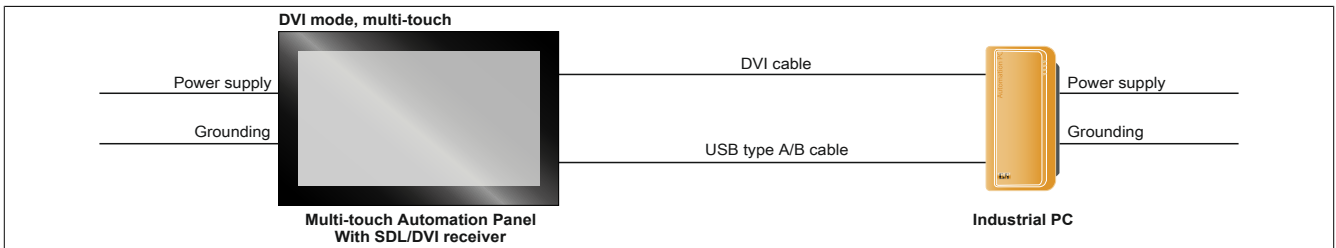

Availability of interfaces on the Automation Panel with SDL/DVI receiver:

Panel In	✓	USB In	✓ USB 2.0	Power supply	✓	Brightness controls	✓
USB1, USB2	✓ USB 2.0	COM touch screen inter-face	x	Grounding	✓		

Maximum cable length: 5 m

Requirements

- Automation Panel with SDL/DVI receiver
- B&R industrial PC with DVI interface
- DVI cable, USB type A/B cable

2.2.1.2.3 General limitations / Special considerations

- Key and LED data is not transferred.
- Data from operating elements is not transferred.
- Service and diagnostic data is not transferred.
- Maximum cable length is limited to 5 m.

2.2.1.3 SDL3 mode

Smart Display Link 3 (SDL3) technology transfers all communication channels between a B&R industrial PC and panel up to 100 m over a standard Ethernet cable (min. Cat 6a). An RJ45 connector ideal for narrow spaces such as feed-throughs and swing arm system is used to connect to the device.

2.2.1.3.1 SDL3 mode with SDL3 transmitter

In the SDL3 operating mode with an SDL3 transmitter in the B&R industrial PC, all communication between the Automation Panel and B&R industrial PC is handled using a single SDL3 cable.

In addition to display data, information from the touch screen and matrix keys as well as service and diagnostic data is transferred. The Automation Panel can be installed up to 100 m from the B&R industrial PC. USB 2.0 is also transferred over this distance and fully integrated in SDL3. External modules are not necessary for this.

The brightness of the display can be set using the ADI Control Center.

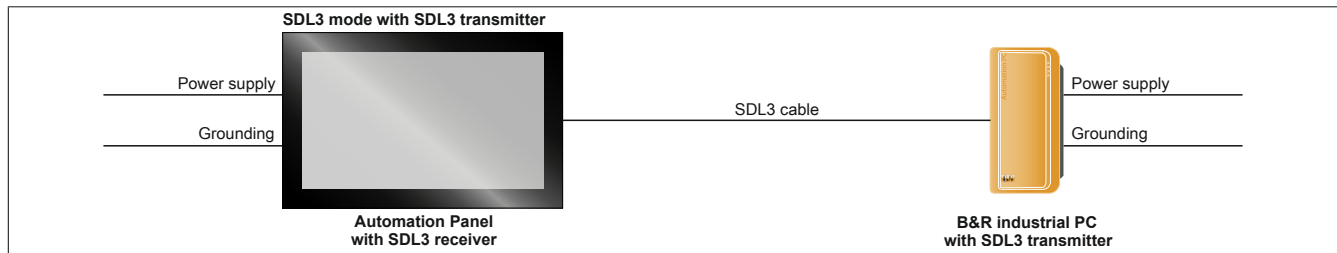

Availability of interfaces on the Automation Panel with SDL3 receiver:

SDL3 interface ✓ USB1, USB2 ✓ USB 2.0 Power supply ✓ Grounding ✓

Maximum cable length of SDL3: 100 m

Requirements

- Automation Panel with SDL3 receiver
- B&R industrial PC with SDL3 interface
- SDL3/SDL4 cable

2.2.1.3.2 General limitations / Special considerations

- The USB 2.0 transfer rate is limited to 30 Mbit/s with SDL3.
- The SDL3 transmitter constantly emulates a display using EDID data and hot plugging code; this allows DVI-compatible operation. As a result, improperly displayed images are possible during operation with multiple displays. In Windows, a connected panel is registered by the graphics driver even in the following situations:
 - No cable is connected.
 - A connection has not yet been established between the SDL3 link module and the SDL3 transmitter.

These improperly displayed images can be circumvented by making suitable configurations in BIOS or via the graphics driver.

2.2.1.4 SDL4 operation

Smart Display Link 4 (SDL4) technology transfers all communication channels between a B&R industrial PC and panel up to 100 m over a standard Ethernet cable (min. Cat 6a). An RJ45 connector ideal for narrow spaces such as feed-throughs and swing arm system is used to connect to the device.

2.2.1.4.1 SDL4 operation with SDL4 transmitter

In the SDL4 operating mode with an SDL4 transmitter in the B&R industrial PC, all communication between the Automation Panel and B&R industrial PC is handled using a single SDL4 cable.

In addition to display data, information from the touch screen and matrix keys as well as service and diagnostic data is transferred. The Automation Panel can be installed up to 100 m from the B&R industrial PC. USB 2.0 is also transferred over this distance and fully integrated in SDL4. External modules are not necessary for this.

The brightness of the display can be set using the ADI Control Center, for example.

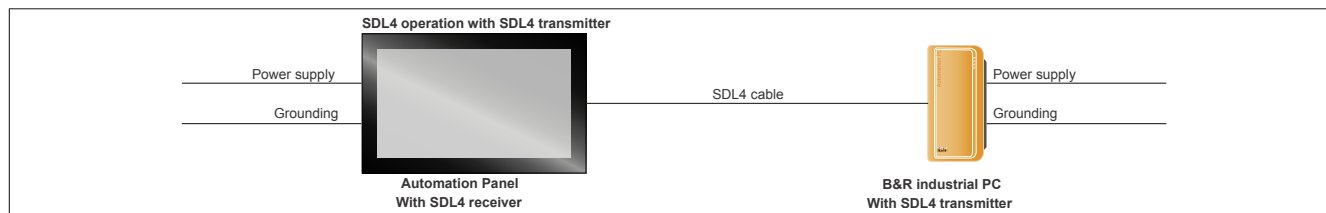

Availability of interfaces on the Automation Panel with SDL4 receiver:

SDL4 interface ✓ USB1, USB2 ✓ USB 2.0 Power supply ✓ Grounding ✓

Maximum cable length of SDL4: 100 m

Requirements

- Automation Panel with SDL4 receiver
- B&R industrial PC with SDL4 interface
- SDL3/SDL4 cable

2.2.1.4.2 General limitations

- The USB 2.0 transfer rate is limited to 150 Mbit/s with SDL4.
- The SDL4 transmitter constantly emulates a display using EDID data and hot plugging code; this allows DVI-compatible operation. As a result, improperly displayed images are possible during operation with multiple displays. In Windows, a connected panel is registered by the graphics driver even in the following situations:
 - No cable is connected.
 - A connection has not yet been established between the SDL4 link module and SDL4 transmitter.

These improperly displayed images can be circumvented by making suitable configurations in BIOS or via the graphics driver.

2.2.2 Mechanical properties

2.2.2.1 Installation diagrams

Information:

When installing the Automation Panel 1000, be sure to leave sufficient space for air circulation as well as additional space for operation and maintenance of the device.

Installation diagrams

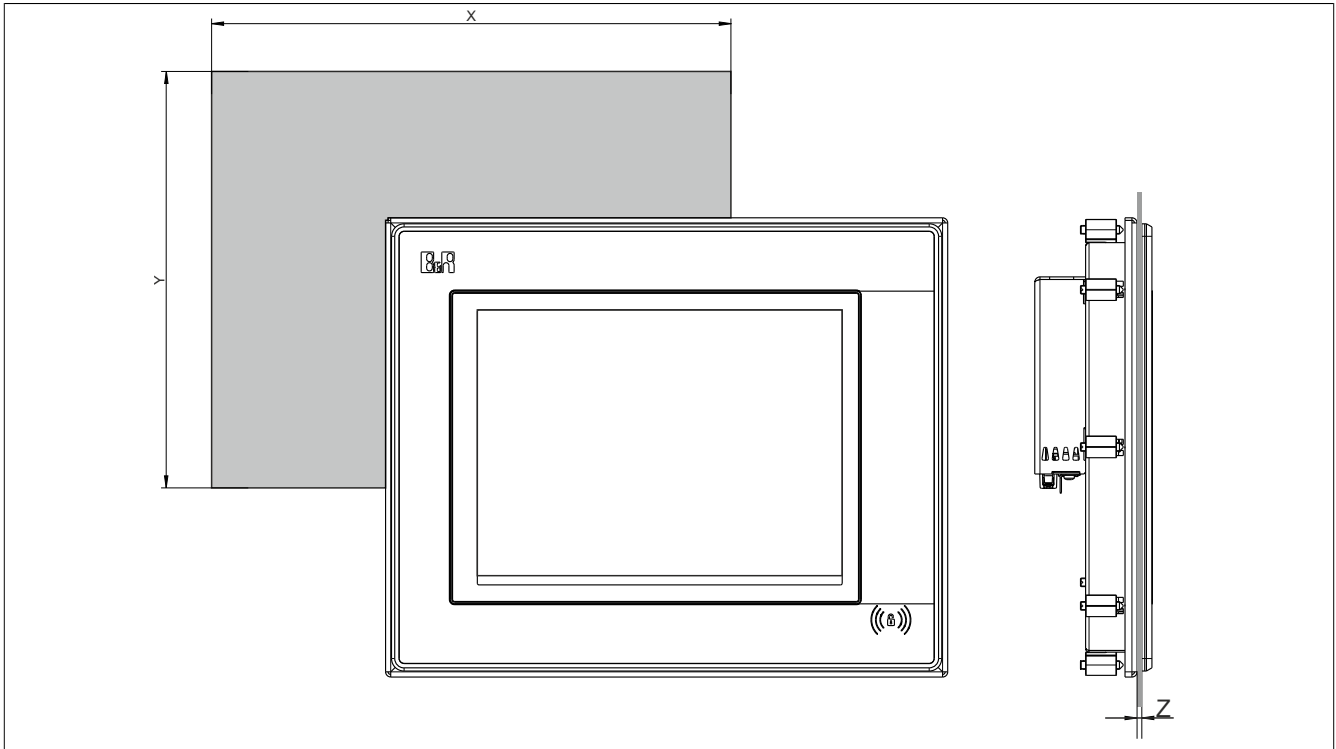

All dimensions are specified in mm.

The cutout tolerances are +0 mm / -0.5 mm.

Display type	Model number	X	Y	Z min.	Z max.	Number of retaining clips	
7" single-touch	5AP1120.0702-I00	199	143	1	8	9	
10.4" single-touch	5AP1125.1043-I00	303	243	1	10	14	
10.4" single-touch	5AP1125.1044-I00	303	243	1	10	14	
15" single-touch	5AP1125.1505-I00	415	313	2	10	18	

Table 5: AP1000 panels with retaining clips - Installation diagrams

Dimension "Z" describes the thickness of the wall or control cabinet panel.

A 2.5 mm hex screwdriver is needed to tighten and remove the screw on the retaining clips. The maximum tightening torque of the retaining clips is 1 Nm.

2.2.2.2 Spacing for air circulation

In order to ensure sufficient air circulation, the specified clearance values must be observed above, below, to the side and behind the device. For the minimum specified clearance, see the following diagrams. This applies to all variants.

Information:

The following figure and table illustrate the complete system from a thermal point of view. Additional space needed to operate or service the device must be taken into account during installation.

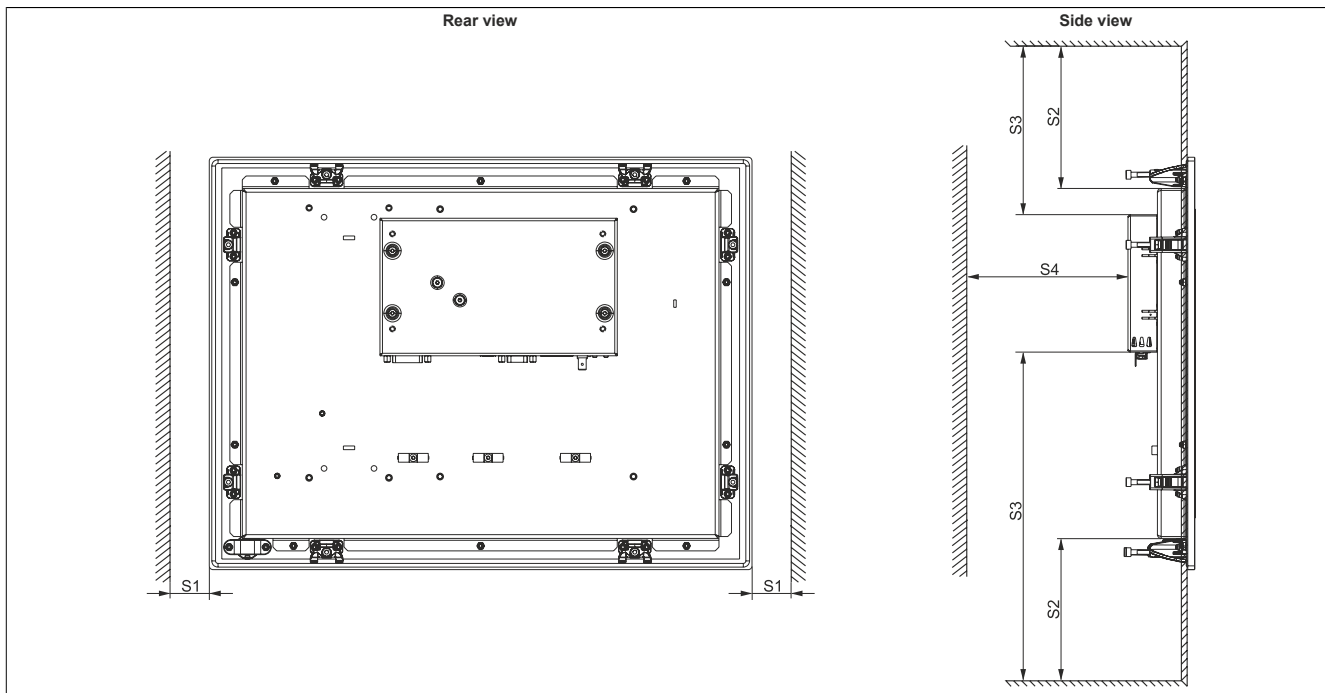

Figure 1: Automation Panel 1000 - Spacing for air circulation

S1: ≥ 10 mm

S2: ≥ 80 mm

S3: ≥ 50 mm

S4: ≥ 50 mm

Caution!

The spacing specifications for air circulation are based on the worst-case scenario for operation at the maximum specified ambient temperature. The maximum specified ambient temperature must not be exceeded!

If the spacing specifications for air circulation cannot be observed, then the maximum specified temperatures for the temperature sensors (see "[Temperature sensor positions](#)" on page 28) must be monitored by the user and appropriate measures taken if they are exceeded.

2.2.2.3 Mounting orientations

The following diagrams show the approved mounting orientations for the Automation Panel 1000. The AP1000 must be mounted as illustrated and described below.

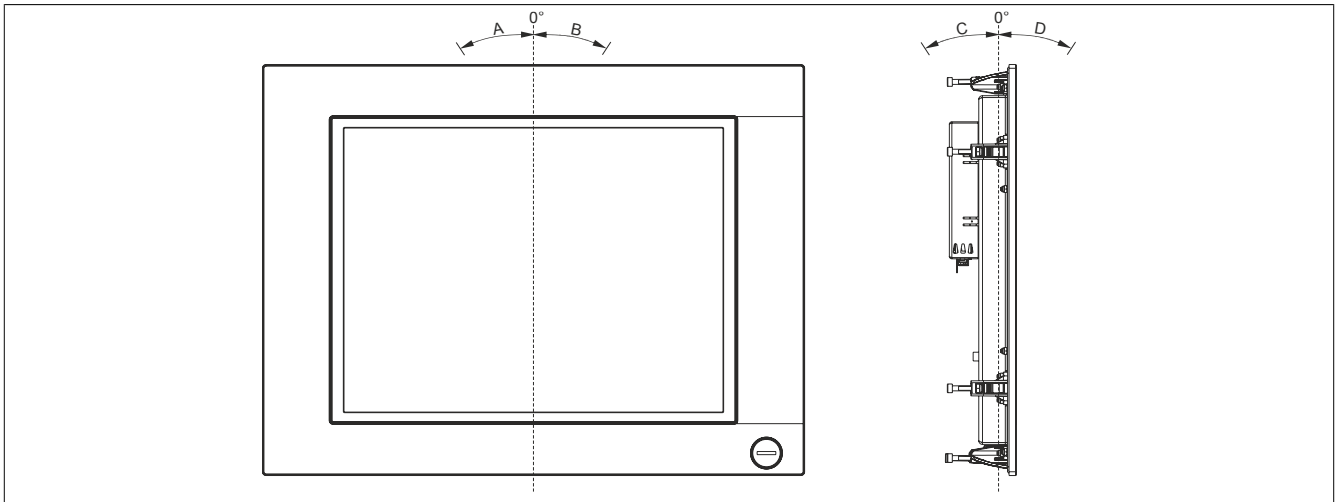

Figure 2: Automation Panel 1000 - Mounting orientation

If "✓" is marked for the panel, it can be used at the maximum ambient temperature (see [Maximum ambient temperature](#)) of the complete system without problems.

If there is a specific temperature for the panel in a particular mounting orientation, for example "55", then the ambient temperature is not permitted to exceed this temperature.

Mounting orientations for the Automation Panel 1000 with SDL/DVI receiver

			Panels			
			5AP1120.0702-100	5AP1125.1043-100	5AP1125.1044-100	5AP1125.1505-100
All temperature values in degrees Celsius (°C) at 500 meters above sea level.						
Mounting orientation	0°	0°	✓	✓	✓	✓
	A	-1° to -90° (counterclockwise)	✓	✓	✓	✓
	B	+1° to +90° (clockwise)	✓	✓	✓	✓
	C, D	±180° (interfaces on top)	✓	✓	✓	✓
	C	-1° to -45°	✓	✓	✓	✓
	D	+1° to +90° (display facing down)	✓	✓	✓	✓

Table 6: Automation Panel 1000 with SDL/DVI receiver - Mounting orientations

Mounting orientations for the Automation Panel 1000 with SDL3 receiver

			Panels			
			5AP1120.0702-100	5AP1120.1043-100	5AP1125.1044-100	5AP1120.1505-100
All temperature values in degrees Celsius (°C) at 500 meters above sea level.						
Mounting orientation	0°	0°	✓	✓	✓	✓
	A	-1° to -90° (counterclockwise)	✓	✓	✓	✓
	B	+1° to +90° (clockwise)	✓	✓	✓	✓
	C, D	±180° (interfaces on top)	✓	✓	✓	✓
	C	-1° to -45°	✓	✓	✓	✓
	D	+1° to +90° (display facing down)	55	55	55	55

Table 7: Automation Panel 1000 with SDL3 receiver - Mounting orientations

Mounting orientations for the Automation Panel 1000 with SDL4 receiver

			Panels			
			5AP1120.0702-I00	5AP1120.1043-I00	5AP1125.1044-I00	5AP1120.1505-I00
All temperature values in degrees Celsius (°C) at 500 meters above sea level.						
Mounting orientation	0°	0°				
	A	-1° to -90° (counterclockwise)	✓	✓	✓	✓
	B	+1° to +90° (clockwise)	✓	✓	✓	✓
	C, D	±180° (interfaces on top)	✓	✓	✓	✓
	C	-1° to -45°	✓	✓	✓	✓
	D	+1° to +90° (display facing down)	55	55	55	55

Table 8: Automation Panel 1000 with SDL4 receiver - Mounting orientations

2.2.2.4 Weight specifications

All weights are specified in g (grams).

Display type	Model number	Weight	
7.0" single-touch	5AP1120.0702-I00	1900	
10.4" single-touch	5AP1125.1043-I00	4100	
10.4" single-touch	5AP1125.1044-I00	4300	
15.0" single-touch	5AP1125.1505-I00	6900	

Table 9: AP1000 panels - Weight

Link module type	Model number	Weight
SDL/DVI receiver	5DLSDL.1001-00	538
SDL3 receiver	5DLSD3.1001-00	527
SDL4 receiver	5DLSD4.1001-00	525

Table 10: Link modules - Weight

2.2.3 Environmental characteristics

2.2.3.1 Temperature specifications

Various panels can be combined with various link modules. The many different configurations possible result in varying maximum ambient temperatures, which can be seen in the following table in this section.

Information:

The maximum specified ambient temperatures for operation were determined under worst-case conditions. Experience has shown that higher ambient temperatures can be achieved in typical applications, e.g. in Microsoft Windows. Testing and evaluation in this regard must be performed on-site by the user in each individual case (temperatures can be read in BIOS or using the B&R Control Center, for example).

Information regarding worst-case conditions

- BurnInTest tool (BurnInTest V4.0 Pro from Passmark Software) for simulating a 100% load on the interface via loopback adapters (serial interface, USB interfaces)
- Maximum system expansion and power consumption

2.2.3.1.1 Maximum ambient temperature

All specifications are valid for non-condensing operation.

		Link module			Location of sensor(s)
		SDL/DVI	SDL3	SDL4	
All temperature values in degrees Celsius (°C) at 500 meters above sea level.					
The maximum ambient temperature is typically derated by 1°C per 1000 meters starting at 500 meters above sea level.					
Maximum ambient temperature		60	60	60	
What else can also be operated at the max. ambient temperature, or is there a limitation?					
Panels	5AP1120.0702-I00	✓	✓	✓	Display - See temperature sensor position
	5AP1125.1043-I00	✓	✓	✓	
	5AP1125.1044-I00	✓	✓	✓	
	5AP1125.1505-I00	✓	✓	✓	

1) The maximum ambient temperature for SDL3 link module 5DLS3.1001-00 < Rev. A5 with the corresponding panel is reduced by 5°C.

Table 11: Maximum ambient temperature during operation

2.2.3.1.2 Minimum ambient temperature during operation

All specifications are valid for non-condensing operation.

	Link module			Location of sensor(s)	
	SDL/DVI	SDL3	SDL4		
	5DLSDL.1001-00	5DLS3.1001-00	5DLS4.1001-00		
All temperature values in degrees Celsius (°C) at 500 meters above sea level.					
The maximum ambient temperature is typically derated by 1°C per 1000 meters starting at 500 meters above sea level.					
Minimum ambient temperature					
0°C					
What else can also be operated at the min. ambient temperature, or is there a limitation?					
Panels	5AP1120.0702-100	✓	✓	✓	Display - See temperature sensor position
	5AP1125.1043-100	✓	✓	✓	
	5AP1125.1044-100	✓	✓	✓	
	5AP1125.1505-100	✓	✓	✓	

Table 12: Minimum ambient temperature during operation

2.2.3.1.3 How to determine the maximum ambient temperature

1. Select the link module.
2. The "Maximum ambient temperature" row shows the maximum ambient temperature for the complete system, including the respective link module.

Information:

Maximum temperature data is for operation at 500 meters. The maximum ambient temperature is typically derated by 1°C per 1000 meters (starting at 500 meters above sea level).

3. The panel determines if there are temperature limits.

If "✓" is marked for the installed component, it can be used at the maximum ambient temperature of the complete system without problems.

If there is a specific temperature next to the component, for example "45", then the ambient temperature of the complete system is not permitted to exceed this temperature.

2.2.3.1.4 Ambient temperature during storage and transport

The following table provides an overview of the minimum and maximum ambient temperatures for storing and transporting the complete system. Limitations are possible through the use of individual components.

Display type	Model number	Storage	Transport
12.1" single-touch	5AP923.1215-00	-25 to 80°C	-25 to 80°C
15.0" single-touch	5AP923.1505-00	-25 to 80°C	-25 to 80°C
19.0" single-touch	5AP923.1906-00 ≤ D0	-20 to 60°C	-20 to 60°C
19.0" single-touch	5AP923.1906-00 ≥ E0	-25 to 70°C	-25 to 70°C
15.6" multi-touch	5AP933.156B-00 ≤ C0	-10 to 60°C	-10 to 60°C
15.6" multi-touch	5AP933.156B-00 ≥ D0	-25 to 70°C	-25 to 70°C
18.5" multi-touch	5AP933.185B-00 ≤ C0	-10 to 60°C	-10 to 60°C
18.5" multi-touch	5AP933.185B-00 ≥ D0	-20 to 60°C	-20 to 60°C
21.5" multi-touch	5AP933.215C-00 ≤ C0	-10 to 60°C	-10 to 60°C
21.5" multi-touch	5AP933.215C-00 ≥ D0	-20 to 60°C	-20 to 60°C
24.0" multi-touch	5AP933.240C-00 ≤ C0	-10 to 60°C	-10 to 60°C
24.0" multi-touch	5AP933.240C-00 ≥ D0	-30 to 70°C	-30 to 70°C

Table 13: AP9x3 panels - Ambient temperature during storage and transport

Link module	Model number	Storage	Transport
SDL/DVI receiver	5DLSDL.1001-00	-20 to 60°C	-20 to 60°C
SDL3 receiver	5DLS3.1001-00	-20 to 60°C	-20 to 60°C
SDL4 receiver	5DLS4.1001-00	-20 to 60°C	-20 to 60°C

Table 14: Link modules - Ambient temperature during storage and transport

2.2.3.1.5 Temperature monitoring

A sensor in the display monitors the temperature of the AP1000 panel. For the position of the temperature sensor, see [2.2.3.1.6 "Temperature sensor positions" on page 28](#). The specified values in [2.2.3.1.6 "Temperature sensor positions" on page 28](#) represent the defined maximum temperature for this measurement point. An alarm is not triggered if the temperature is exceeded. These temperatures can be read in BIOS or approved Microsoft Windows operating systems using the B&R Control Center.

2.2.3.1.6 Temperature sensor positions

These temperatures¹⁾ can be read in BIOS or Microsoft Windows operating systems using the B&R Control Center²⁾. For applications that do not run in Windows, temperatures can be evaluated using the B&R implementation guide. In addition to the implementation guide, there are also programs available in MS-DOS.

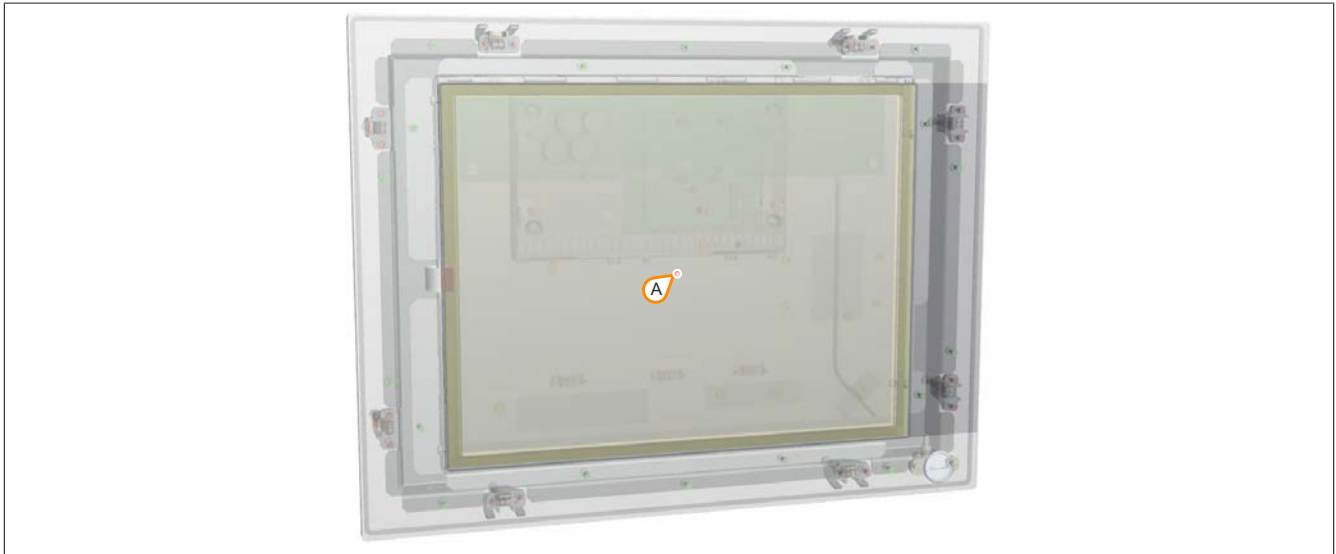

Figure 3: Automation Panel 1000 - Temperature sensor position

ADI sensors	Position	Measurement point for	Measurement	Max. specified
Panel	A	Display	Temperature of the display (sensor integrated on the panel).	5AP1120.0702-I00: 85°C 5AP1125.1043-I00: 90°C 5AP1125.1044-I00: 90°C 5AP1125.1505-I00: 90°C

Table 15: Temperature sensor position

¹⁾ The temperature measured approximates the immediate ambient temperature but may also be influenced by neighboring components.

²⁾ The ADI driver that includes the B&R Control Center is available in the Downloads section of the B&R website (www.br-automation.com).

2.2.3.2 Humidity

The following table lists the minimum and maximum relative humidity values for the individual components that are relevant for the humidity limitations of a complete system. The lowest and highest common values are always used when establishing these limits.

Display type	Model number	Operation	Storage	Transport
7.0" single-touch	5AP1120.0702-I00	20 to 90%	10 to 90%	10 to 90%
10.4" single-touch	5AP1125.1043-I00	5 to 90%	5 to 90%	5 to 90%
10.4" single-touch	5AP1125.1044-I00	5 to 90%	5 to 90%	5 to 90%
15.0" single-touch	5AP1125.1505-I00	8 to 90%	8 to 90%	8 to 90%

Table 16: AP1000 panels - Relative humidity

All values apply to non-condensing operation/storage/transport.

Link module type	Model number	Operation	Storage	Transport
SDL/DVI receiver	5DLSDL.1001-00	5 to 90%	5 to 95%	5 to 95%
SDL3 receiver	5DLSD3.1001-00	5 to 90%	5 to 95%	5 to 95%
SDL4 receiver	5DLSD4.1001-00	5 to 90%	5 to 95%	5 to 95%

Table 17: Link modules - Humidity

The specifications listed correspond to the relative humidity at an ambient temperature of 30°C. For more detailed information about specific temperature-dependent humidity values, see the technical data for the individual components.

2.2.3.3 Vibration

The following table provides an overview of the maximum vibration values of the complete system. Limitations are possible through the use of individual components.

	Operation ¹⁾		Storage ¹⁾²⁾	Transport ¹⁾²⁾
	Continuous	Periodic		
Automation Panel 1000	2 to 9 Hz: 1.75 mm amplitude 9 to 200 Hz: 0.5 g	2 to 9 Hz: 3.5 mm amplitude 9 to 200 Hz: 1 g	2 to 8 Hz: 7.5 mm amplitude 8 to 200 Hz: 2 g 200 to 500 Hz: 4 g	2 to 8 Hz: 7.5 mm amplitude 8 to 200 Hz: 2 g 200 to 500 Hz: 4 g

Table 18: Vibration

- 1) Testing is performed in accordance with EN 60068-2-6.
2) This value applies to a device in its original packaging.

2.2.3.4 Shock

The following table provides an overview of the maximum shock values of the complete system. Limitations are possible through the use of individual components.

	Operation ¹⁾	Storage ¹⁾²⁾	Transport ¹⁾²⁾
Automation Panel 1000	15 g, 11 ms	30 g, 6 ms	30 g, 6 ms

Table 19: Shock

- 1) Testing is performed in accordance with EN 60068-2-27.
2) This value applies to a device in its original packaging.

2.2.3.5 Protection

In accordance with EN 60529, the Automation Panel 1000 has IP69K protection on the front and IP20 protection on the back under the following conditions:

- Correct installation of the Automation Panel 1000
- All covers and components are installed on the interfaces and slots.
- All environmental conditions are observed.

The Automation Panel 1000 with hygienic design also has "Type 4X indoor use only" under the same conditions per UL50.

2.2.4 Electrical characteristics

2.2.4.1 +24 VDC power supply

Danger!

This device is only permitted to be supplied by a SELV/PELV power supply or with safety extra-low voltage (SELV) per EN 60950.

The 3-pin male connector required for connecting the power supply is not included in delivery. It can be ordered from B&R using model number 0TB103.9 (screw clamp terminal block) or 0TB103.91 (cage clamp terminal block).

For the pinout, see the following table. The supply voltage is protected internally by a soldered fuse (10 A, fast-acting) to prevent damage to the device in the event of overload (fuse replacement necessary) or if the voltage supply is connected incorrectly (reverse polarity protection → fuse replacement not necessary). The device must be returned to B&R for repairs if the fuse is destroyed in the event of error.

+24 VDC power supply		3-pin male power supply connector +24 VDC power supply 
Protected against reverse polarity		
Pin	Description	
1	+	
2	Functional ground	
3	-	
Model number	Short description	
	Terminal blocks	
0TB103.9	Male connector 24 V 5.08 3-pin screw clamp terminal block	
0TB103.91	Male connector 24 V 5.08 3-pin cage clamp terminal block	

Table 20: +24 VDC voltage supply connection

Electrical characteristics	
Nominal voltage	24 VDC ±25%, SELV ¹⁾
Nominal current	Max. 3 A
Overvoltage category in accordance with EN 61131-2	II
Electrical isolation	Yes
Uninterruptible power supply	No

1) EN 60950 requirements must be observed.

2.2.4.2 Power calculation

In order to calculate the total power of the Automation Panel, the power rating of the display being used (see "[Link modules - Power calculation](#)") must be added to the power rating of the link module being used.

The following specifications are maximum values without additional consumers (USB devices, etc.).

Link module	Model number	Total power consumption of link module
SDL/DVI receiver	5DLSL.1001-00	Max. 3.6 W without USB consumer Max. 8.6 W with USB consumer
SDL3 receiver	5DLS3.1001-00	Max. 8.1 W without USB consumer Max. 13.1 W with USB consumer
SDL4 receiver	5DLS4.1001-00	Max. 8.1 W without USB consumer Max. 13.1 W with USB consumer

Table 21: Link modules - Power calculation

Display type	Model number	+5 V	3V3	+12 V
7.0" single-touch	5AP1120.0702-I00	-	1 W	6.5 W
10.4" single-touch	5AP1125.1043-I00	-	1.5 W	7.5 W
10.4" single-touch	5AP1125.1044-I00	-	1.5 W	7.5 W
15.0" single-touch	5AP1125.1505-I00	-	2.5 W	18 W

Table 22: AP1000 panels - Power calculation

2.2.4.3 Block diagrams

The following block diagram shows the simplified structure of the 5DLSDL.1001-00 SDL/DVI receiver link module.

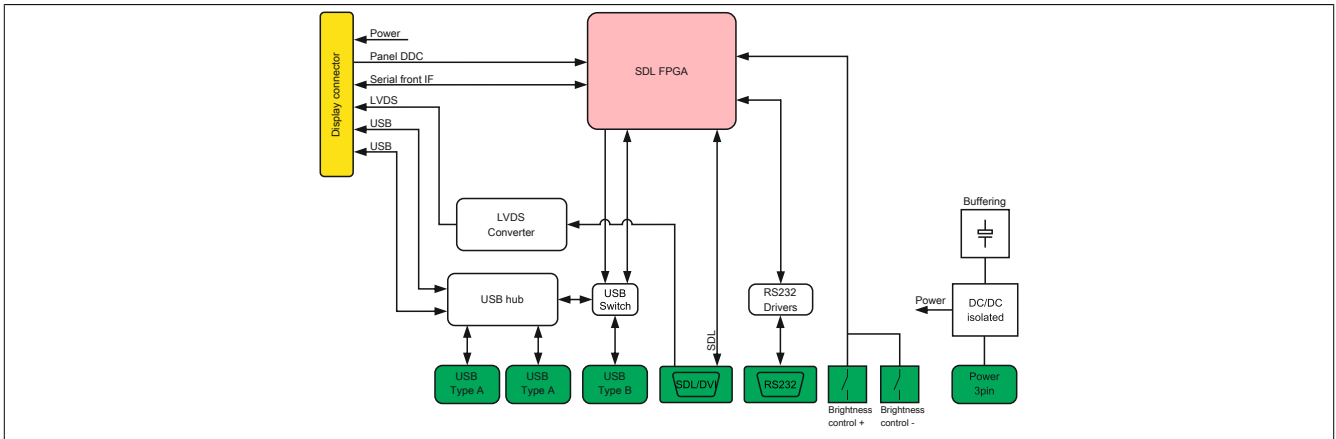

Figure 4: SDL/DVI receiver link module - Block diagram

The following block diagram shows the simplified structure of the 5DLS3.1001-00 SDL3 receiver link module.

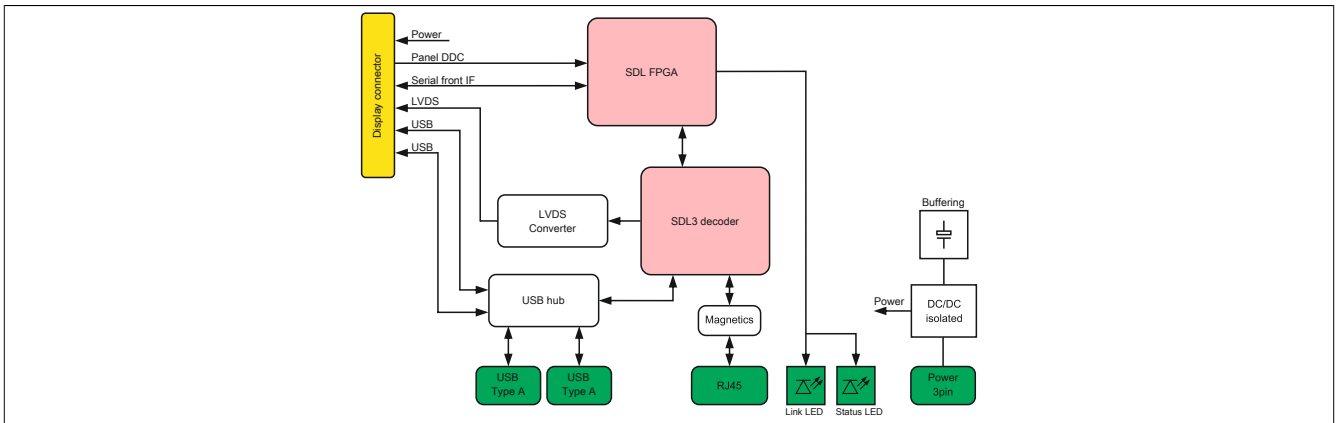

Figure 5: SDL3 receiver link module - Block diagram

The following block diagram shows the simplified structure of the 55DLS4.1001-00 SDL4 receiver link module.

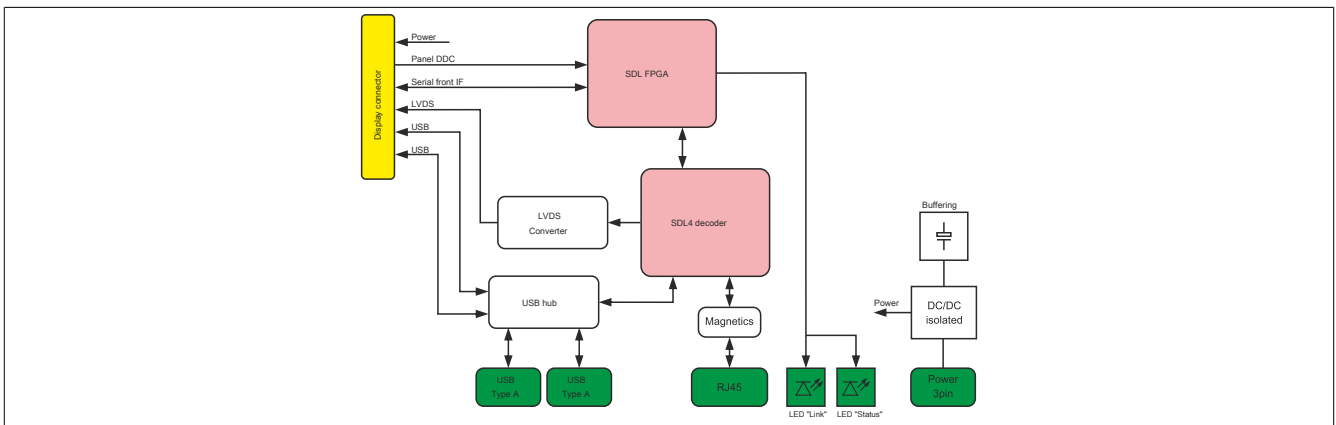

Figure 6: SDL4 receiver link module - Block diagram

2.2.5 SDL/DVI receiver - 5DLSDL.1001-00 device interfaces

2.2.5.1 Overview

SDL/DVI receiver interfaces are located on the back of the Automation Panel 1000.

Information about SDL/DVI mode can be found in sections "[SDL operation](#)" on page 17 and "[DVI operation](#)" on page 18.

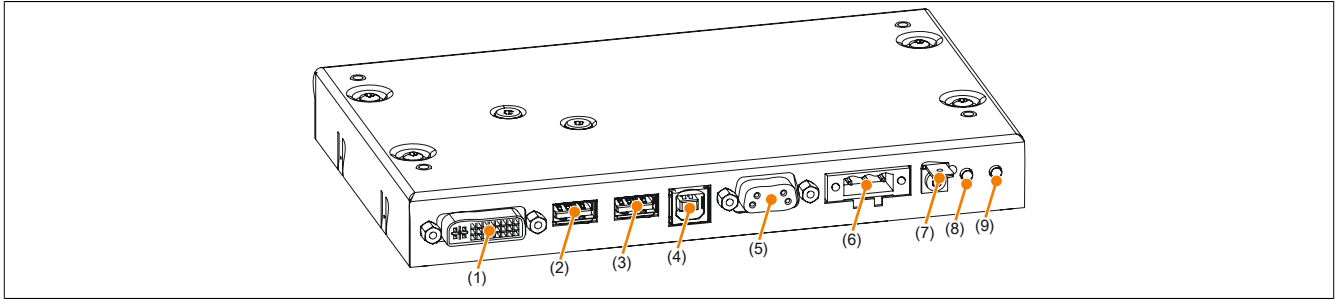

Figure 7: Overview of interfaces - SDL/DVI receiver link module

No.	Type of interface		No.	Type of interface	
1	Panel In SDL/DVI	"Panel In interface"	6	24 VDC power	"+24 VDC power supply"
2	USB1	"USB interfaces"	7	Grounding	"Grounding"
3	USB2	"USB interfaces"	8	Brightness (DVI) +	"Brightness controls"
4	USB In	"USB In interface"	9	Brightness (DVI) -	"Brightness controls"
5	COM	"COM serial interface"			

2.2.5.2 +24 VDC power supply

Danger!

This device is only permitted to be supplied by a SELV/PELV power supply or with safety extra-low voltage (SELV) per EN 60950.

The 3-pin male connector required for connecting the power supply is not included in delivery. It can be ordered from B&R using model number 0TB103.9 (screw clamp terminal block) or 0TB103.91 (cage clamp terminal block).

For the pinout, see the following table. The supply voltage is protected internally by a soldered fuse (10 A, fast-acting) to prevent damage to the device in the event of overload (fuse replacement necessary) or if the voltage supply is connected incorrectly (reverse polarity protection → fuse replacement not necessary). The device must be returned to B&R for repairs if the fuse is destroyed in the event of error.

+24 VDC power supply	
Protected against reverse polarity	
Pin	Description
1	+
2	Functional ground
3	-
Model number	Short description
	Terminal blocks
0TB103.9	Male connector 24 V 5.08 3-pin screw clamp terminal block
0TB103.91	Male connector 24 V 5.08 3-pin cage clamp terminal block

3-pin male power supply connector

+24 VDC power supply



Table 23: +24 VDC voltage supply connection

Electrical characteristics	
Nominal voltage	24 VDC ±25%, SELV ¹⁾
Nominal current	Max. 3 A
Overvoltage category in accordance with EN 61131-2	II
Electrical isolation	Yes
Uninterruptible power supply	No

1) EN 60950 requirements must be observed.

2.2.5.2.1 Grounding

Caution!

Functional ground (pin 2 of power supply and ground connection) must be connected to the central grounding point (e.g. of the control cabinet or system) using the shorted path with the lowest resistance and largest possible wire cross section. This type of grounding is mandatory to ensure the system functions properly.

The ground connection is located next to the power supply for the link module.

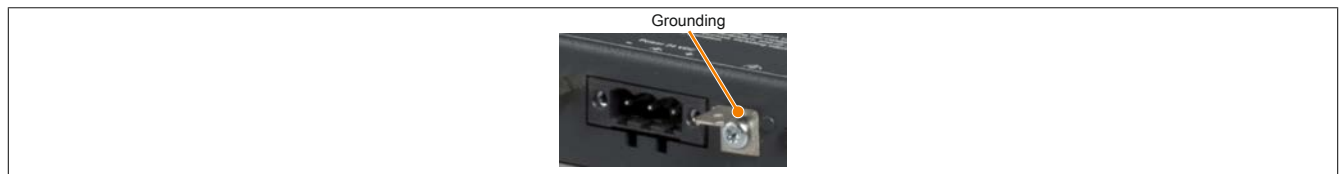

Figure 8: Ground connection

The ground connection must be used, for example, to fasten a copper strip to a central grounding point in the control cabinet or system where the device is installed. The largest possible conductor cross section should be used (at least 2.5 mm²).

2.2.5.3 Panel In interface

The Panel In interface can be used for SDL or DVI transfer. For more information, see "SDL operation" on page 17 and "DVI operation" on page 18.

Panel In interface - SDL (Smart Display Link) / DVI	
The following overview lists the video signals available on the panel input. For additional details, see the technical data for the link module or panel being used.	
Link module	Video signals
5DLSDL.1001-00	SDL, DVI



Table 24: Panel In interface - SDL, DVI

Information:

The hardware and graphics drivers of approved operating systems support the hot plugging of display devices to the Panel In interface for service purposes. The panel connector is specified for max. 100 connection cycles.

Information:

If a display device with touch screen is connected to the Panel In interface and then disconnected again during operation (hot plugging), it may be necessary to recalibrate the touch screen.

2.2.5.3.1 Pinout

Pin	Assignment	Description	Pin	Assignment	Description
1	TMDS data 2-	DVI lane 2 (negative)	16	HPD	Hot plug detect
2	TMDS data 2+	DVI lane 2 (positive)	17	TMDS data 0-	DVI lane 0 (negative)
3	TMDS data 2/4 SHIELD	Shield for data pair 2 and 4	18	TMDS data 0+	DVI lane 0 (positive)
4	SDL-	SDL lane (negative)	19	TMDS Data 0/ XUSB1 SHIELD	Shield for data pair 0 and USB1
5	SDL+	SDL lane (positive)	20	XUSB1-	USB lane 1 (negative)
6	DDC clock	DDC-based control signal (clock)	21	XUSB1+	USB lane 1 (positive)
7	DDC data	DDC-based control signal (data)	22	TMDS clock shield	Shield for clock pair
8	N/C	Not connected	23	TMDS clock+	DVI clock (positive)
9	TMDS data 1-	DVI lane 1 (negative)	24	TMDS clock -	DVI clock (negative)
10	TMDS DATA 1+	DVI lane 1 (negative) HDMI clock (positive)	C1	N/C	Not connected
11	TMDS DATA 1/ XUSB0 SHIELD	Shield for data pair 1 and USB0	C2	N/C	Not connected
12	XUSB0-	USB lane 0 (negative)	C3	N/C	Not connected
13	XUSB0+	USB lane 0 (positive)	C4	N/C	Not connected
14	+5 V power	+5 V power supply	C5	N/C	Not connected
15	Ground (return for +5 V, HSync and VSync)	Ground			



Table 25: DVI interface - Pinout

2.2.5.3.2 USB transfer in SDL and DVI mode

Information:

The USB transfer rate is limited to USB 1.1 in SDL mode.

In DVI mode, the maximum USB transfer rate depends on the USB interface and USB hub on the industrial PC.

2.2.5.3.3 Cable lengths and resolutions for SDL transmission

The following table lists the relationship between segment lengths and maximum resolution depending on the SDL cable being used:

SDL cable Segment length [m]	Resolution						
	VGA 640 x 480	SVGA 800 x 600	XGA 1024 x 768	HD 1366 x 768	SXGA 1280 x 1024	UXGA 1600 x 1200	FHD 1920 x 1080
0.8	5CASDL.0008-00	5CASDL.0008-00	5CASDL.0008-00	5CASDL.0008-00	5CASDL.0008-00	5CASDL.0008-00	5CASDL.0008-00
1.8	5CASDL.0018-00	5CASDL.0018-00	5CASDL.0018-00	5CASDL.0018-00	5CASDL.0018-00	5CASDL.0018-00	5CASDL.0018-00
	5CASDL.0018-01	5CASDL.0018-01	5CASDL.0018-01	5CASDL.0018-01	5CASDL.0018-01	5CASDL.0018-01	5CASDL.0018-01
	5CASDL.0018-03	5CASDL.0018-03	5CASDL.0018-03	5CASDL.0018-03	5CASDL.0018-03	5CASDL.0018-03	5CASDL.0018-03
5	5CASDL.0050-00	5CASDL.0050-00	5CASDL.0050-00	5CASDL.0050-00	5CASDL.0050-00	5CASDL.0050-00	5CASDL.0050-00
	5CASDL.0050-01	5CASDL.0050-01	5CASDL.0050-01	5CASDL.0050-01	5CASDL.0050-01	5CASDL.0050-01	5CASDL.0050-01
	5CASDL.0050-03	5CASDL.0050-03	5CASDL.0050-03	5CASDL.0050-03	5CASDL.0050-03	5CASDL.0050-03	5CASDL.0050-03
10	5CASDL.0100-00	5CASDL.0100-00	5CASDL.0100-00	5CASDL.0100-00	5CASDL.0100-00	5CASDL.0100-00	5CASDL.0100-00
	5CASDL.0100-01	5CASDL.0100-01	5CASDL.0100-01	5CASDL.0100-01	5CASDL.0100-01	5CASDL.0100-01	5CASDL.0100-01
	5CASDL.0100-03	5CASDL.0100-03	5CASDL.0100-03	5CASDL.0100-03	5CASDL.0100-03	5CASDL.0100-03	5CASDL.0100-03
15	5CASDL.0150-00	5CASDL.0150-00	5CASDL.0150-00	5CASDL.0150-00	5CASDL.0150-00	-	-
	5CASDL.0150-01	5CASDL.0150-01	5CASDL.0150-01	5CASDL.0150-01	5CASDL.0150-01	-	-
	5CASDL.0150-03	5CASDL.0150-03	5CASDL.0150-03	5CASDL.0150-03	5CASDL.0150-03	-	5CASDL.0150-03
20	5CASDL.0200-00	5CASDL.0200-00	5CASDL.0200-00	5CASDL.0200-00	5CASDL.0200-00	-	-
	5CASDL.0200-03	5CASDL.0200-03	5CASDL.0200-03	5CASDL.0200-03	5CASDL.0200-03	-	5CASDL.0200-03
25	5CASDL.0250-00	5CASDL.0250-00	5CASDL.0250-00	5CASDL.0250-00	-	-	-
	5CASDL.0250-03	5CASDL.0250-03	5CASDL.0250-03	5CASDL.0250-03	-	-	-
30	5CASDL.0300-00	5CASDL.0300-00	-	-	-	-	-
	5CASDL.0300-03	5CASDL.0300-03	5CASDL.0300-13	5CASDL.0300-13	5CASDL.0300-13	-	5CASDL.0300-13
40	5CASDL.0400-13	5CASDL.0400-13	5CASDL.0400-13	5CASDL.0400-13	5CASDL.0400-13	-	5CASDL.0400-13

Table 26: Cable lengths and resolutions for SDL transmission

2.2.5.3.4 Cable lengths and resolutions for DVI transfer

The following table shows the relationship between segment length and maximum resolution depending on the DVI cable:

DVI cable Segment length [m]	Resolution						
	VGA 640 x 480	SVGA 800 x 600	XGA 1024 x 768	HD 1366 x 768	SXGA 1280 x 1024	UXGA 1600 x 1200	FHD 1920 x 1080
1.8	5CADVI.0018-00	5CADVI.0018-00	5CADVI.0018-00	5CADVI.0018-00	5CADVI.0018-00	5CADVI.0018-00	5CADVI.0018-00
5	5CADVI.0050-00	5CADVI.0050-00	5CADVI.0050-00	5CADVI.0050-00	5CADVI.0050-00	5CADVI.0050-00	5CADVI.0050-00

Table 27: Cable lengths and resolutions for DVI transfer

The maximum cable length for DVI transfer is limited to 5 m due to the USB specification.

2.2.5.4 USB interfaces

The link module is equipped with a USB 2.0 (Universal Serial Bus) host controller with multiple USB interfaces, 2 of which are accessible externally for the user.

Warning!

Peripheral USB devices can be connected to the USB interfaces. Due to the large number of USB devices available on the market, B&R cannot guarantee their functionality. Functionality is ensured when using the USB devices available from B&R.

Caution!

Because this interface is designed according to general PC specifications, extreme care should be exercised with regard to EMC, cable routing, etc.

USB1, USB2

The USB1 and USB2 interfaces are available for the user to connect USB devices.

Depending on the transfer method (SDL or DVI mode), the transfer rate of the USB1 and USB2 interfaces may be limited. Possible transfer methods are listed in section "Connection options" on page 16.

Transfer method	USB type	Max. cable length
SDL mode 1	USB 1.1	40 m
SDL mode 2	USB 2.0	5 m
DVI mode, single-touch	USB 2.0	5 m
DVI mode, multi-touch	USB 2.0	5 m

Universal Serial Bus (USB1, USB2) ¹⁾	
Type	USB 2.0
Design	Type A
Transfer rate	Low speed (1.5 Mbit/s), full speed (12 Mbit/s), high speed (480 Mbit/s)
Current load ²⁾ USB1, USB2	Total max. 1 A
Cable length USB 2.0	Max. 5 m (without hub)

2x USB type A, female

USB1

USB2



Table 28: USB1/USB2 interface

- 1) The interfaces, etc. available on the device or module have been numbered as such for easy identification. This numbering may differ from that used by the particular operating system.
- 2) Each USB interface is protected by a shared, maintenance-free "USB current-limiting circuit breaker" (total max. 1 A).

2.2.5.5 USB In interface

The USB In interface is a USB 2.0 type B interface that is used to transfer USB data. It must be connected to the USB interface on the output device (e.g. B&R Industrial PC) when using DVI mode or SDL operating mode 2 as the transfer method. Possible transfer methods are listed in section "Connection options" on page 16.

If the interface is connected to an output device (B&R Industrial PC), then USB 2.0 transfer rates are possible on the USB1 and USB2 interfaces.

USB In interface ¹⁾	
Type	USB 2.0
Design	Type B
Transfer rate	Low speed (1.5 Mbit/s), full speed (12 Mbit/s), high speed (480 Mbit/s)
Current-carrying capacity ²⁾	Max. 500 mA
Cable length	Max. 5 m (without hub)

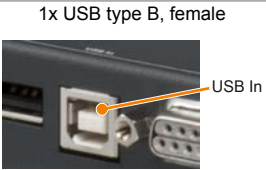

Table 29: USB In interface

- 1) The interfaces, etc. available on the device or module have been numbered as such for easy identification. This numbering may differ from that used by the particular operating system.
- 2) Each USB interface is protected by a maintenance-free "USB current-limiting circuit breaker" (max. 500 mA).

2.2.5.6 COM serial interface

The serial interface is only available for use with single-touch displays in DVI mode. It is used to transfer data from the resistive touch screen and must be connected to a serial interface on the output device.

COM serial interface ¹⁾	
RS232	
Type	RS232, modem-capable, not electrically isolated
UART	16550-compatible, 16-byte FIFO
Transfer rate	Max. 115 kbit/s
Bus length	Max. 15 m
Pin	Assignment
1	N/C
2	RXD
3	TXD
4	N/C
5	GND
6	N/C
7	RTS
8	CTS
9	N/C

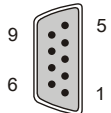

Table 30: COM - Pinout

- 1) The interfaces, etc. available on the device or module have been numbered as such for easy identification. This numbering may differ from that used by the particular operating system.

2.2.5.7 Brightness controls

The brightness controls can be used to configure the brightness of the backlight on the Automation Panel in DVI mode. These buttons have no effect in SDL mode; in this case, the brightness can be configured in the B&R Control Center, for example.

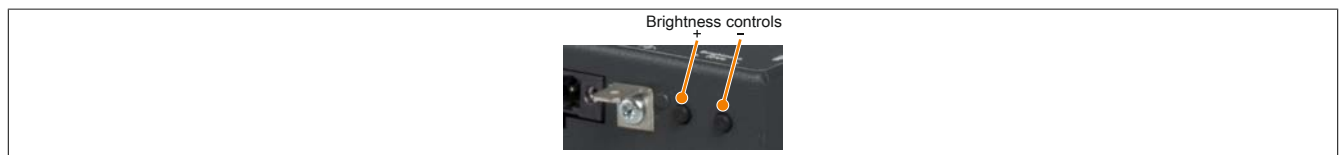

Figure 9: Brightness controls

2.2.6 5DLSD3.1001-00 SDL3 receiver - Device interfaces

2.2.6.1 Overview

SDL3 receiver interfaces are located on the back of the Automation Panel 1000.

Information about SDL3 mode can be found in section "SDL3 mode" on page 19.

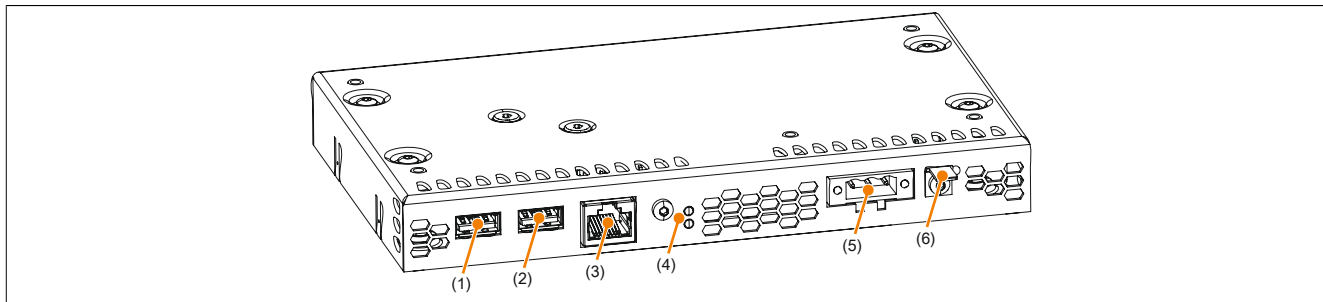

Figure 10: Overview of interfaces - SDL3 receiver link module

No.	Type of interface		No.	Type of interface	
1	USB1	"USB interfaces"	4	SDL3 In LEDs	"SDL3 In LEDs"
2	USB2	"USB interfaces"	5	24 VDC power	"+24 VDC power supply"
3	SDL3 In	"SDL3 In interface"	6	Grounding	"Grounding"

2.2.6.2 +24 VDC power supply

Danger!

This device is only permitted to be supplied by a SELV/PELV power supply or with safety extra-low voltage (SELV) per EN 60950.

The 3-pin male connector required for connecting the power supply is not included in delivery. It can be ordered from B&R using model number 0TB103.9 (screw clamp terminal block) or 0TB103.91 (cage clamp terminal block).

For the pinout, see the following table. The supply voltage is protected internally by a soldered fuse (10 A, fast-acting) to prevent damage to the device in the event of overload (fuse replacement necessary) or if the voltage supply is connected incorrectly (reverse polarity protection → fuse replacement not necessary). The device must be returned to B&R for repairs if the fuse is destroyed in the event of error.

+24 VDC power supply		3-pin male power supply connector +24 VDC power supply
Protected against reverse polarity		
Pin	Description	
1	+	
2	Functional ground	
3	-	
Model number	Short description	
Terminal blocks		
0TB103.9	Male connector 24 V 5.08 3-pin screw clamp terminal block	
0TB103.91	Male connector 24 V 5.08 3-pin cage clamp terminal block	

Table 31: +24 VDC voltage supply connection

Electrical characteristics	
Nominal voltage	24 VDC ±25%, SELV ¹⁾
Nominal current	Max. 3 A
Overvoltage category in accordance with EN 61131-2	II
Electrical isolation	Yes
Uninterruptible power supply	No

1) EN 60950 requirements must be observed.

2.2.6.3 Grounding

Caution!

Functional ground (pin 2 of power supply and ground connection) must be connected to the central grounding point (e.g. of the control cabinet or system) using the shorted path with the lowest resistance and largest possible wire cross section. This type of grounding is mandatory to ensure the system functions properly.

The ground connection is located next to the power supply for the link module.

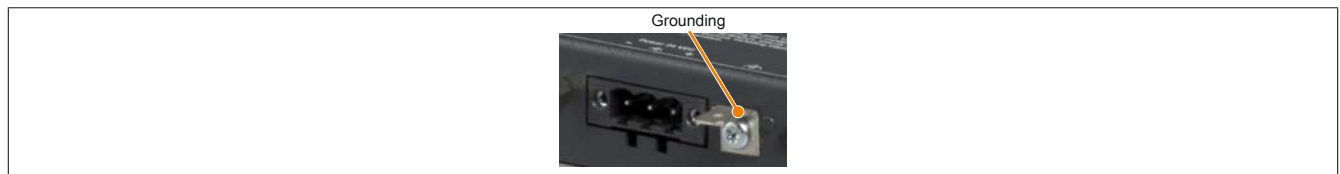

Figure 11: Ground connection

The ground connection must be used, for example, to fasten a copper strip to a central grounding point in the control cabinet or system where the device is installed. The largest possible conductor cross section should be used (at least 2.5 mm²).

2.2.6.4 SDL3 In interface

The SDL3 In interface is a female RJ45 connector and operated with SDL3 transmission technology. For more information, see section "SDL3 mode" on page 19.

SDL3 In interface - SDL3	
The following overview lists the video signals available on the panel input. For additional details, see the technical data for the link module or panel being used.	
Link module	Video signals
5DLSD3.1001-00	SDL3

Female RJ45 connector

1

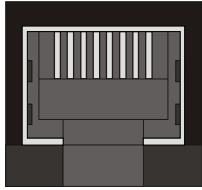

Table 32: SDL3 In interface

Information:

The hardware and graphics drivers of approved operating systems support the hot plugging of display devices to the SDL3 In interface for service purposes. The female RJ45 connector is specified for 500 connection cycles.

Information:

If a display device with touch screen is connected to the SDL3 In interface and then disconnected again during operation (hot plugging), it may be necessary to recalibrate the touch screen.

2.2.6.4.1 Cable lengths and resolutions for SDL3 transmission

The maximum cable length for SDL3 transfers is 100 m with a B&R SDL3/SDL4 cable (regardless of the panel resolution).

2.2.6.5 SDL3 In LEDs

The SDL3 In LEDs are located next to the SDL3 In interface.

SDL3 In LEDs			
LED	Color	Status	Function
Link	Yellow	On	Indicates an active SDL3 connection
		Off	No active SDL3 connection
Status	Yellow	On	SDL3 connection established and OK
		Off	No active SDL3 connection
		Blinking	Indicates the SDL3 connection is OK, but a firmware image is corrupt



Table 33: SDL3 In LEDs

2.2.6.6 USB interfaces

The link module is equipped with a USB 2.0 (Universal Serial Bus) host controller with multiple USB interfaces, 2 of which are accessible externally for the user.

Warning!

Peripheral USB devices can be connected to the USB interfaces. Due to the large number of USB devices available on the market, B&R cannot guarantee their functionality. Functionality is ensured when using the USB devices available from B&R.

Caution!

Because this interface is designed according to general PC specifications, extreme care should be exercised with regard to EMC, cable routing, etc.

USB1, USB2

The USB1 and USB2 interfaces are available for the user to connect USB devices.

Universal Serial Bus (USB1, USB2) ¹⁾	
Type	USB 2.0
Design	Type A
Transfer rate	Low speed (1.5 Mbit/s), full speed (12 Mbit/s), high speed (30 Mbit/s)
Current load ²⁾ USB1, USB2	Total max. 1 A
Cable length USB 2.0	Max. 5 m (without hub)

2x USB type A, female

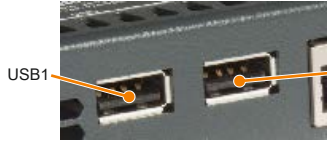

Table 34: USB1/USB2 interface

- 1) The interfaces, etc. available on the device or module have been numbered as such for easy identification. This numbering may differ from that used by the particular operating system.
- 2) Each USB interface is protected by a shared, maintenance-free "USB current-limiting circuit breaker" (total max. 1 A).

2.2.7 5DLSD4.1001-00 SDL4 receiver - Device interfaces

2.2.7.1 Overview

SDL4 receiver interfaces are located on the back of the Automation Panel 1000.

For information about SDL4 mode, see section [SDL4 operation](#).

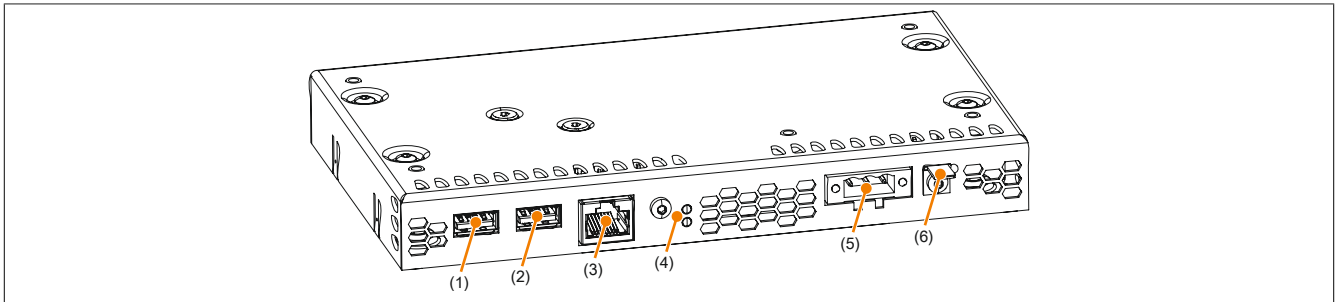

Figure 12: Overview of interfaces - SDL4 receiver link module

No.	Type of interface		No.	Type of interface	
1	USB1	USB interfaces	4	SDL4 In LEDs	"SDL4 In LEDs"
2	USB2	USB interfaces	5	24 VDC power	"+24 VDC power supply"
3	SDL4 In	"SDL4 In interface"	6	Grounding	"Grounding"

2.2.7.2 +24 VDC power supply

Danger!

This device is only permitted to be supplied by a SELV/PELV power supply or with safety extra-low voltage (SELV) per EN 60950.

The 3-pin male connector required for connecting the power supply is not included in delivery. It can be ordered from B&R using model number 0TB103.9 (screw clamp terminal block) or 0TB103.91 (cage clamp terminal block).

For the pinout, see the following table. The supply voltage is protected internally by a soldered fuse (10 A, fast-acting) to prevent damage to the device in the event of overload (fuse replacement necessary) or if the voltage supply is connected incorrectly (reverse polarity protection → fuse replacement not necessary). The device must be returned to B&R for repairs if the fuse is destroyed in the event of error.

+24 VDC power supply		3-pin male power supply connector +24 VDC power supply
Protected against reverse polarity		
Pin	Description	
1	+	
2	Functional ground	
3	-	
Model number	Short description	
Terminal blocks		
0TB103.9	Male connector 24 V 5.08 3-pin screw clamp terminal block	
0TB103.91	Male connector 24 V 5.08 3-pin cage clamp terminal block	

Table 35: +24 VDC voltage supply connection

Electrical characteristics	
Nominal voltage	24 VDC ±25%, SELV ¹⁾
Nominal current	Max. 3 A
Overvoltage category in accordance with EN 61131-2	II
Electrical isolation	Yes
Uninterruptible power supply	No

1) EN 60950 requirements must be observed.

2.2.7.2.1 Grounding

Caution!

Functional ground (pin 2 of power supply and ground connection) must be connected to the central grounding point (e.g. of the control cabinet or system) using the shorted path with the lowest resistance and largest possible wire cross section. This type of grounding is mandatory to ensure the system functions properly.

The ground connection is located next to the power supply for the link module.

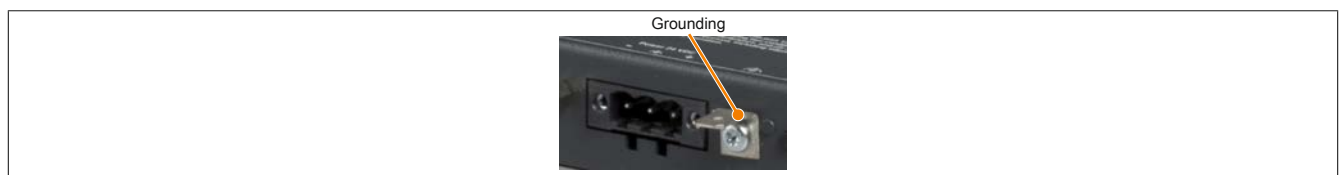

Figure 13: Ground connection

The ground connection must be used, for example, to fasten a copper strip to a central grounding point in the control cabinet or system where the device is installed. The largest possible conductor cross section should be used (at least 2.5 mm²).

2.2.7.3 SDL4 In interface

The SDL4 In interface is a female RJ45 connector and operated with SDL4 transmission technology. For more information, see section "SDL4 operation" on page 20.

SDL4 In interface - SDL4	
The following overview shows the possible video signals available on the Panel input. For additional details, see the technical data for the link module or panel being used.	
Link module	Video signals
5DLSD4.1001-00	SDL4

RJ45 connector, female

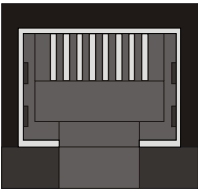

Table 36: SDL4 In interface

Information:

Hot plugging display devices on the SDL4 In interface for service purposes is supported by the hardware and graphics drivers of approved operating systems. The female RJ45 connector is specified for 500 connection cycles.

Information:

If a display device with touch screen is connected to the SDL4 In interface and then disconnected again during operation (hot plugging), it may be necessary to recalibrate the touch screen.

2.2.7.3.1 Cable lengths and resolutions for SDL4 transfer

The maximum cable length for SDL4 transfers is 100 m with a B&R "SDL3/SDL4 cables" (regardless of the panel resolution).

2.2.7.4 SDL4 In LEDs

The SDL4 In LEDs are located next to the SDL4 In interface.

SDL4 In LEDs			
LED	Color	Status	Explanation
Link	Yellow	On	Indicates an active SDL4 connection.
		Off	No active SDL4 connection.
Status	Yellow	On	The SDL4 connection is established and OK.
		Off	No active SDL4 connection.
		Blinking	Indicates the SDL4 connection is OK, but a firmware image is corrupt



Table 37: SDL4 In LEDs

2.2.7.5 USB interfaces

The link module is equipped with a Universal Serial Bus 2.0 (USB) host controller with multiple USB interfaces, 2 of which are accessible externally for the user.

Warning!

Peripheral USB devices can be connected to the USB interfaces. Due to the large number of USB devices available on the market, B&R cannot guarantee their functionality. Functionality is ensured when using the USB devices available from B&R.

Caution!

Because this interface is designed according to general PC specifications, extreme care should be taken with regard to EMC, wiring, etc.

USB1, USB2

The USB1 and USB2 interfaces are available for the user to connect USB devices.

Universal Serial Bus (USB1, USB2) ¹⁾	
Type	USB 2.0
Design	Type A
Transfer rate	Low speed (1.5 Mbit/s), full speed (12 Mbit/s), high speed (30 Mbit/s)
Current-carrying capacity ²⁾ USB1, USB2	Total max. 1 A
Cable length USB 2.0	Max. 5 m (without hub)

2x USB type A, female

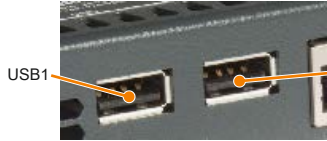

Table 38: USB1/USB2 interface

- 1) The interfaces, etc. available on the device or module have been numbered as such for the purpose of clear differentiation. This numbering may deviate from the numbering used by the respective operating system, however.
- 2) The USB interfaces are protected by a shared maintenance-free "USB current-limiting switch" (total max. 1 A).

2.2.8 Features of AP1000 panels

A wide selection of different display sizes and panels with touch screen and RFID read/write unit are available. The following table provides an overview of the panels and their features.

Display type	Model number	Touch screen	RFID read/write unit
7.0" single-touch	5AP1120.0702-I00	Single-touch	No
10.4" single-touch	5AP1125.1043-I00	Single-touch	Yes
10.4" single-touch	5AP1125.1044-I00	Single-touch	Yes
15.0" single-touch	5AP1125.1505-I00	Single-touch	Yes



2.2.8.1 RFID read/write unit

The RFID read/write unit is located on the front of the panel and can be used to read MIFARE and ISO 15693 tags. The following transponder tags can be used with this RFID read/write unit:

Model number	Short description
5A9010.43	Transponder tag, black housing, read/write, SLI, 1 kbit, 13.56 MHz
5A9010.44	Transponder tag, white housing, read/write, SLI, 1 kbit, 13.56 MHz
5A9010.45	Transponder tag, yellow housing, read/write, SLI, 1 kbit, 13.56 MHz
5A9010.46	Transponder tag, red housing, read/write, SLI, 1 kbit, 13.56 MHz
5A9010.47	Transponder tag, green housing, read/write, SLI, 1 kbit, 13.56 MHz
5A9010.48	Transponder tag, blue housing, read/write, SLI, 1 kbit, 13.56 MHz
5A9020.43	Transponder tag, black housing, MIFARE Classic, 1 kB, 13.56 MHz read/write
5A9020.44	Transponder tag, white housing, MIFARE Classic, 1 kB, 13.56 MHz read/write
5A9020.45	Transponder tag, yellow housing, MIFARE Classic, 1 kB, 13.56 MHz read/write
5A9020.46	Transponder tag, red housing, MIFARE Classic, 1 kB, 13.56 MHz read/write
5A9020.47	Transponder tag, green housing, MIFARE Classic, 1 kB, 13.56 MHz read/write
5A9020.48	Transponder tag, blue housing, MIFARE Classic, 1 kB, 13.56 MHz read/write

Information:

The tag must be held ca. 0.5 cm from the front of the device for the RFID read/write unit to function properly (ISO 15693 and ISO 14443). Placing flush may cause a temporary loss of communication.

Information:

For more information about the RFID read/write unit, please refer to the technical description for the 5E9020.29 device.

2.3 Individual components

2.3.1 Panels

2.3.1.1 5AP1120.0702-I00

2.3.1.1.1 General information

- 7" TFT color display, WVGA
- Single-touch (analog, resistive), with fully laminated panel overlay (shatter protection)
- IP69K protection (front)
- Front and housing made of stainless steel (hygienic design, no dirt-collecting edge)

2.3.1.1.2 Order data

Model number	Short description	Figure
5AP1120.0702-I00	Panels - Automation Panel 7.0" WVGA TFT - 800 x 480 pixels (16:10) - Single-touch (resistive), with fully integrated touch screen, without dirt-collecting edge - Non-rusting stainless steel front - Control cabinet installation - Landscape format - For PPC2100/PPC2200 - For link modules - Compatible with 5PP520.0702-B00	

Table 39: 5AP1120.0702-I00 - Order data

2.3.1.1.3 Technical data

Model number	5AP1120.0702-I00
General information	
B&R ID code	0xE88F
Certifications	
CE	Yes
UL	cULus E115267 Industrial control equipment
Display	
Type	TFT color
Diagonal	7.0"
Colors	16 million
Resolution	WVGA, 800 x 480 pixels
Contrast	600:1
Viewing angles	
Horizontal	Direction R = 70° / Direction L = 70°
Vertical	Direction U = 60° / Direction D = 60°
Backlight	
Type	LED
Brightness (dimnable)	Typ. 80 to 500 cd/m ²
Half-brightness time ¹⁾	50,000 h
Touch screen ²⁾	
Technology	Analog, resistive
Controller	B&R, serial, 12-bit
Transmittance	81% ±3%
Operating conditions	
Pollution degree per EN 61131-2	Pollution degree 2
Suitable for hygienic applications	Yes
Degree of protection per EN 60529	Front: IP69K Back: IP20 (only with installed link module or installed system unit)
Protection per UL 50	Front: Type 4X indoor use only

Table 40: 5AP1120.0702-I00 - Technical data

Technical data

Model number	5AP1120.0702-I00
Mechanical properties	
Front ³⁾	
Frame	Stainless steel 1.4301
Keypad overlay	
Material	Polyester
Light background	RAL 9006
Dark gray border around display	RAL 7024
Gasket	Silicone rubber
Dimensions	
Width	217 mm
Height	161 mm
Weight	1,600 g

Table 40: 5AP1120.0702-I00 - Technical data

- 1) At an ambient temperature of 25°C. Reducing the brightness by 50% can increase the half-brightness time by approximately 50%.
- 2) Touch screen drivers for approved operating systems are available for download in the Downloads section of the B&R website (www.br-automation.com).
- 3) There may be visible deviations in the color and surface appearance depending on the process or batch.

2.3.1.1.4 Dimensions

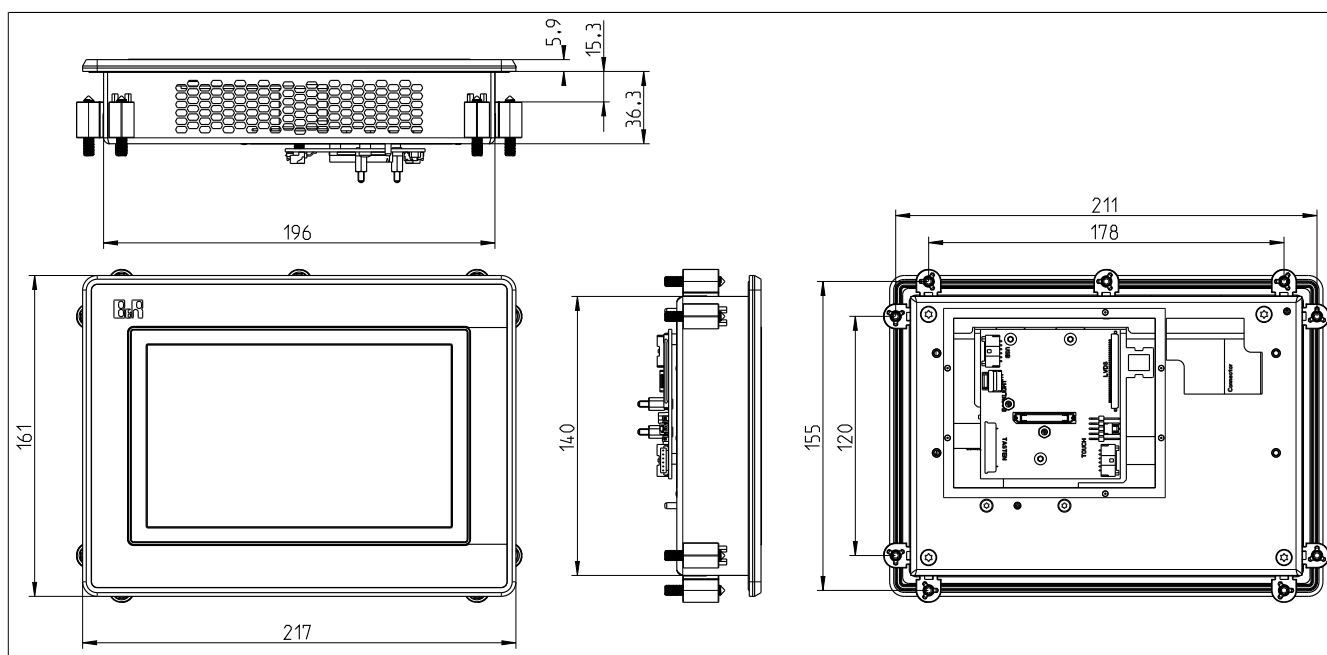

Figure 14: 5AP1120.0702-I00 - Dimensions

Information:

2D and 3D drawings (in DXF and STEP format) can be downloaded from the B&R website (www.br-automation.com).

2.3.1.2 5AP1125.1043-I00

2.3.1.2.1 General information

- 10.4" color TFT display, VGA
- Single-touch (analog, resistive), with fully laminated panel overlay (shatter protection)
- IP69K protection (front)
- Front and housing made of stainless steel (hygienic design, no dirt-collecting edge)
- RFID read/write transponder unit

2.3.1.2.2 Order data

Model number	Short description	Figure
	Panels	
5AP1125.1043-I00	- Automation Panel 10.4" VGA TFT - 640 x 480 pixels (4:3) - Single-touch (analog resistive), with fully integrated touch screen, without dirt-collecting edge - Non-rusting stainless steel front - Control cabinet installation - Landscape format - 13.56 MHz read/write transponder unit - For PPC900/PPC2100/PPC3100/PPC2200 - For link modules - Compatible with 5PP520.1043-B00/5PP520.1043-B10	

Table 41: 5AP1125.1043-I00 - Order data

2.3.1.2.3 Technical data

Model number	5AP1125.1043-I00
General information	
B&R ID code	0xE890
Certifications	
CE	Yes
UL	cULus E115267 Industrial control equipment
Interfaces	
RFID read/write transponder unit	
Type	For I-Code SLI transponder, amplitude modulation and MIFARE Classic
Frequency	13.56 MHz
Read/Write range in air	Approx. 1 to 3 cm
Display	
Type	TFT color
Diagonal	10.4"
Colors	16.2 million
Resolution	VGA, 640 x 480 pixels
Contrast	900:1
Viewing angles	
Horizontal	Direction R = 80° / Direction L = 80°
Vertical	Direction U = 80° / Direction D = 80°
Backlight	
Type	LED
Brightness (dimnable)	Typ. 22.5 to 450 cd/m ²
Half-brightness time ¹⁾	70,000 h
Touch screen ²⁾	
Technology	Analog, resistive
Controller	B&R, serial, 12-bit
Transmittance	81% ±3%
Operating conditions	
Pollution degree per EN 61131-2	Pollution degree 2
Suitable for hygienic applications	Yes
Degree of protection per EN 60529	Front: IP69K Back: IP20 (only with installed link module or installed system unit)
Protection per UL 50	Front: Type 4X indoor use only

Table 42: 5AP1125.1043-I00 - Technical data

Technical data

Model number	5AP1125.1043-I00
Mechanical properties	
Front ³⁾	
Frame	Stainless steel 1.4301
Keypad overlay	
Material	Polyester
Light background	RAL 9006
Dark gray border around display	RAL 7024
Gasket	Silicone rubber
Dimensions	
Width	321 mm
Height	261 mm
Weight	4,100 g

Table 42: 5AP1125.1043-I00 - Technical data

- 1) At an ambient temperature of 25°C. Reducing the brightness by 50% can increase the half-brightness time by approximately 50%.
- 2) Touch screen drivers for approved operating systems are available for download in the Downloads section of the B&R website (www.br-automation.com).
- 3) There may be visible deviations in the color and surface appearance depending on the process or batch.

2.3.1.2.4 Dimensions

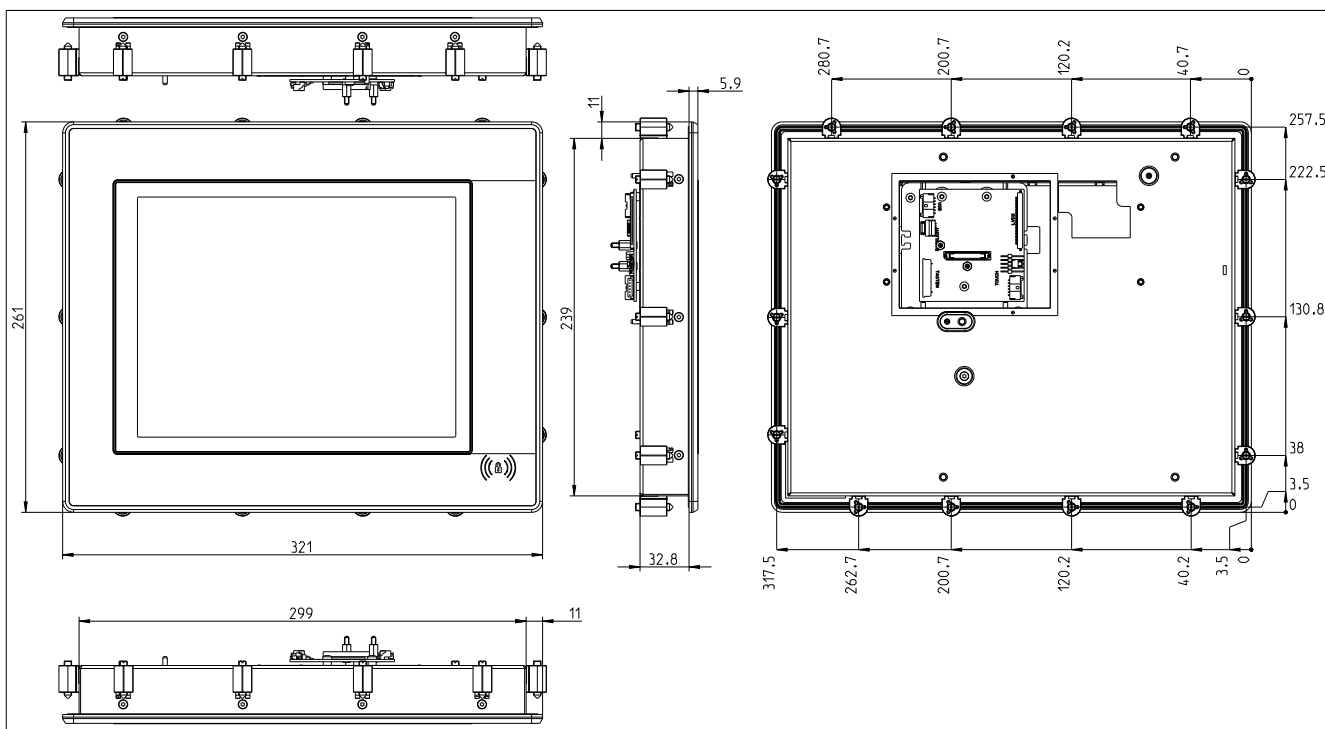

Figure 15: 5AP1125.1043-I00 - Dimensions

Information:

2D and 3D drawings (in DXF and STEP format) can be downloaded from the B&R website (www.br-automation.com).

2.3.1.3 5AP1125.1044-I00

2.3.1.3.1 General information

- 10.4" color TFT display, SVGA
- Single-touch (analog, resistive), with fully laminated panel overlay (shatter protection)
- IP69K protection (front)
- Front and housing made of stainless steel (hygienic design, no dirt-collecting edge)
- RFID read/write transponder unit

2.3.1.3.2 Order data

Model number	Short description	Figure
5AP1125.1044-I00	Panels - Automation Panel 10.4" SVGA TFT - 800 x 600 pixels (4:3) - Single-touch (analog resistive), with fully integrated touch screen, without dirt-collecting edge - Non-rusting stainless steel front - Control cabinet installation - Landscape format - 13.56 MHz read/write transponder unit - For PPC900/PPC2100/PPC3100/PPC2200 - For link modules - Compatible with 5PP520.1043-B00/5PP520.1043-B10	

Table 43: 5AP1125.1044-I00 - Order data

2.3.1.3.3 Technical data

Model number	5AP1125.1044-I00
General information	
B&R ID code	0xE891
Certifications	
CE	Yes
UL	cULus E115267 Industrial control equipment
Interfaces	
RFID read/write transponder unit	
Type	For I-Code SLI transponder, amplitude modulation and MIFARE Classic
Frequency	13.56 MHz
Read/Write range in air	Approx. 1 to 3 cm
Display	
Type	TFT color
Diagonal	10.4"
Colors	16.2 million
Resolution	SVGA, 800 x 600 pixels
Contrast	800:1
Viewing angles	
Horizontal	Direction R / Direction L = 85°
Vertical	Direction U / Direction D = 85°
Backlight	
Type	LED
Brightness (dimnable)	Typ. 22.5 to 450 cd/m ²
Half-brightness time ¹⁾	50,000 h
Touch screen ²⁾	
Technology	Analog, resistive
Controller	B&R, serial, 12-bit
Transmittance	81% ±3%
Operating conditions	
Pollution degree per EN 61131-2	Pollution degree 2
Suitable for hygienic applications	Yes
Degree of protection per EN 60529	Front: IP69K Back: IP20 (only with installed link module or installed system unit)
Protection per UL 50	Front: Type 4X indoor use only

Table 44: 5AP1125.1044-I00 - Technical data

Technical data

Model number	5AP1125.1044-I00
Mechanical properties	
Front ³⁾	
Frame	Stainless steel 1.4301
Keypad overlay	
Material	Polyester
Light background	RAL 9006
Dark gray border around display	RAL 7024
Gasket	Silicone rubber
Dimensions	
Width	321 mm
Height	261 mm
Weight	4,300 g

Table 44: 5AP1125.1044-I00 - Technical data

- 1) At an ambient temperature of 25°C. Reducing the brightness by 50% can increase the half-brightness time by approximately 50%.
- 2) Touch screen drivers for approved operating systems are available for download in the Downloads section of the B&R website (www.br-automation.com).
- 3) There may be visible deviations in the color and surface appearance depending on the process or batch.

2.3.1.3.4 Dimensions

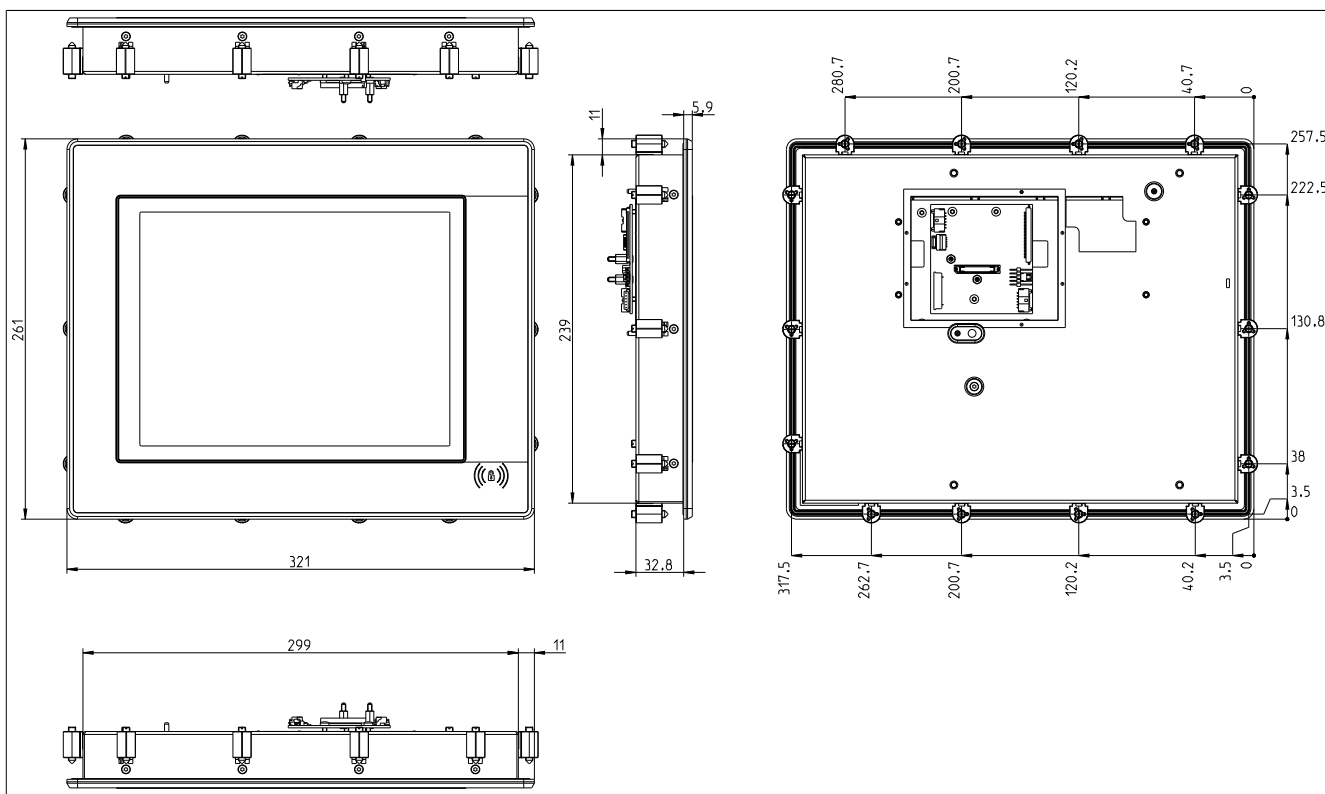

Figure 16: 5AP1125.1044-I00 - Dimensions

Information:

2D and 3D drawings (in DXF and STEP format) can be downloaded from the B&R website (www.br-automation.com).

2.3.1.4 5AP1125.1505-I00

2.3.1.4.1 General information

- 15.5" color TFT display, XGA
- Single-touch (analog, resistive), with fully laminated panel overlay (shatter protection)
- IP69K protection (front)
- Front and housing made of stainless steel (hygienic design, no dirt-collecting edge)
- RFID read/write transponder unit

2.3.1.4.2 Order data

Model number	Short description	Figure
5AP1125.1505-I00	Panels - Automation Panel 15.0" XGA TFT - 1024 x 768 pixels (4:3) - Single-touch (analog resistive), with fully integrated touch screen, without dirt-collecting edge - Non-rusting stainless steel front - Control cabinet installation - Landscape format - 13.56 MHz read/write transponder unit - For PPC900/PPC2100/PPC3100/PPC2200 - For link modules - Compatible with 5PP520.1505-B00/5PP520.1505-B10	

Table 45: 5AP1125.1505-I00 - Order data

2.3.1.4.3 Technical data

Model number	5AP1125.1505-I00
General information	
B&R ID code	0xE892
Certifications	
CE	Yes
UL	cULus E115267 Industrial control equipment
Interfaces	
RFID read/write transponder unit	
Type	For I-Code SLI transponder, amplitude modulation and MIFARE Classic
Frequency	13.56 MHz
Read/Write range in air	Approx. 1 to 3 cm
Display	
Type	TFT color
Diagonal	15.0"
Colors	16.2 million
Resolution	XGA, 1024 x 768 pixels
Contrast	700:1
Viewing angles	
Horizontal	Direction R = 80° / Direction L = 80°
Vertical	Direction U = 70° / Direction D = 70°
Backlight	
Type	LED
Brightness (dimnable)	Typ. 20 to 400 cd/m ²
Half-brightness time ¹⁾	50,000 h
Touch screen ²⁾	
Technology	Analog, resistive
Controller	B&R, serial, 12-bit
Transmittance	81% ±3%
Operating conditions	
Pollution degree per EN 61131-2	Pollution degree 2
Suitable for hygienic applications	Yes
Degree of protection per EN 60529	Front: IP69K Back: IP20 (only with installed link module or installed system unit)
Protection per UL 50	Front: Type 4X indoor use only

Table 46: 5AP1125.1505-I00 - Technical data

Technical data

Model number	5AP1125.1505-I00
Mechanical properties	
Front ³⁾	
Frame	Stainless steel 1.4301
Keypad overlay	
Material	Polyester
Light background	RAL 9006
Dark gray border around display	RAL 7024
Gasket	Silicone rubber
Dimensions	
Width	433 mm
Height	331 mm
Weight	6,900 g

Table 46: 5AP1125.1505-I00 - Technical data

- 1) At an ambient temperature of 25°C. Reducing the brightness by 50% can increase the half-brightness time by approximately 50%.
- 2) Touch screen drivers for approved operating systems are available for download in the Downloads section of the B&R website (www.br-automation.com).
- 3) There may be visible deviations in the color and surface appearance depending on the process or batch.

2.3.1.4.4 Dimensions

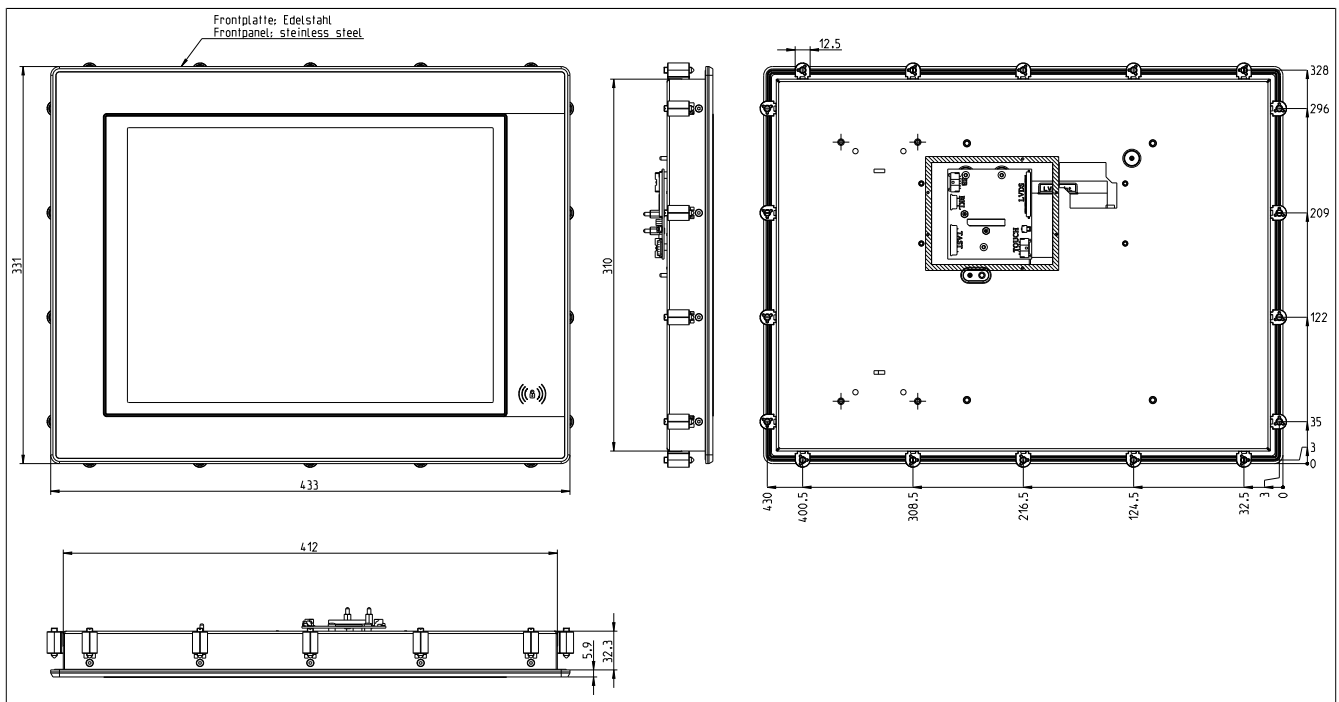

Figure 17: 5AP1125.1505-I00 - Dimensions

Information:

2D and 3D drawings (in DXF and STEP format) can be downloaded from the B&R website (www.br-automation.com).

2.3.2 Link modules

2.3.2.1 5DLSDL.1001-00

2.3.2.1.1 General information

- Link module for Automation Panel 9x3/1000/5000
- 1x SDL/DVI Panel In interface
- 2x USB 2.0 type A
- 1x USB In (USB type B)
- 1x RS232 interface
- Display brightness buttons

2.3.2.1.2 Order data

Model number	Short description	Figure
	Link modules	
5DLSDL.1001-00	Automation Panel link module - SDL/DVI receiver - For Automation Panel 923/933/1000 - For Automation Panel 5000	
	Required accessories	
	Terminal blocks	
0TB103.9	Connector 24 VDC - 3-pin female - Screw clamp terminal block 3.31 mm ²	
0TB103.91	Connector 24 VDC - 3-pin female - Cage clamp terminal block 3.31 mm ²	

Table 47: 5DLSDL.1001-00 - Order data

2.3.2.1.3 Technical data

Information:

The following specifications, properties and limit values apply only to this individual component and may deviate from those that apply to the complete system. For the complete system in which this individual component is used, for example, the data specified for that complete system applies.

Model number	5DLSDL.1001-00
General information	
B&R ID code	0xE1A4
Brightness buttons	Yes ¹⁾
Certifications	
CE	Yes
UL	cULus E115267 Industrial control equipment
HazLoc	cULus HazLoc E180196 Industrial control equipment for hazardous locations Class I, Division 2, Groups ABCD, T4 ²⁾
DNV GL	Temperature: B (0 - 55°C) Humidity: B (up to 100%) Vibration: A (0.7 g) EMC: B (Bridge and open deck) ³⁾
GOST-R	Yes
Interfaces	
COM	
Type	RS232, modem supported, not electrically isolated
Design	DSUB, 9-pin, female
UART	16550-compatible, 16-byte FIFO
Max. baud rate	115 kbit/s
USB	
Quantity	3 (2x Type A; 1x Type B)
Type	USB 2.0 ⁴⁾
Design	2x type A 1x type B
Transfer rate	Low speed (1.5 Mbit/s), full speed (12 Mbit/s), high speed (480 Mbit/s)
Current-carrying capacity	Total max. 1 A ⁵⁾
Panel In	
Design	DVI-D
Type	SDL/DVI
Electrical characteristics	
Nominal voltage	24 VDC ±25%, SELV ⁶⁾

Table 48: 5DLSDL.1001-00 - Technical data

Technical data

Model number	5DLSDL.1001-00
Nominal current	Max. 3 A
Overvoltage category per EN 61131-2	II
Electrical isolation	Yes
Operating conditions	
Pollution degree per EN 61131-2	Pollution degree 2
Mechanical characteristics	
Dimensions	
Width	190 mm
Height	110 mm
Depth	23.6 mm
Weight	538 g

Table 48: 5DLSDL.1001-00 - Technical data

- 1) The brightness controls can be used to configure the brightness of the backlight on the Automation Panel in DVI mode.
- 2) Yes, although applies only if all components installed in the complete system have this certification and the complete system bears the corresponding mark.
- 3) Yes, although applies only if all components installed in the complete system have this certification and are listed on the associated DNV GL certificate for the product family.
- 4) In "SDL mode 1", USB 1.1 transfer rates are the highest possible.
- 5) For the 2 USB type A female connectors.
- 6) EN 60950 requirements must be observed; see section "+24 VDC power supply" of the user's manual.

2.3.2.2 5DLSD3.1001-00

2.3.2.2.1 General information

- Link module for Automation Panel 9x3/1000/5000
- 1x SDL3 Panel In interface
- 2x USB 2.0 type A

2.3.2.2.2 Order data

Model number	Short description	Figure
	Link modules	
5DLSD3.1001-00	Automation Panel link module - SDL3 receiver - For Automation Panel 923/933/1000 - For Automation Panel 5000	
	Required accessories	
	Terminal blocks	
0TB103.9	Connector 24 VDC - 3-pin female - Screw clamp terminal block 3.31 mm ²	
0TB103.91	Connector 24 VDC - 3-pin female - Cage clamp terminal block 3.31 mm ²	
	Optional accessories	
	SDL3/SDL4 cables	
5CASD3.0030-00	SDL3/SDL4 cable - 3 m	
5CASD3.0050-00	SDL3/SDL4 cable - 5 m	
5CASD3.0100-00	SDL3/SDL4 cable - 10 m	
5CASD3.0150-00	SDL3/SDL4 cable - 15 m	
5CASD3.0200-00	SDL3/SDL4 cable - 20 m	
5CASD3.0300-00	SDL3/SDL4 cable - 30 m	
5CASD3.0500-00	SDL3/SDL4 cable - 50 m	
5CASD3.1000-00	SDL3/SDL4 cable - 100 m	

Table 49: 5DLSD3.1001-00 - Order data

2.3.2.2.3 Technical data

Information:

The following specifications, properties and limit values apply only to this individual component and may deviate from those that apply to the complete system. For the complete system in which this individual component is used, for example, the data specified for that complete system applies.

Model number	5DLSD3.1001-00
General information	
LED status indicators	Status, Link
B&R ID code	0xE3FC
Certifications	
CE	Yes
UL	cULus E115267 Industrial control equipment
HazLoc	cULus HazLoc E180196 Industrial control equipment for hazardous locations Class I, Division 2, Groups ABCD, T4 ¹⁾
Interfaces	
USB	
Quantity	2
Type	USB 2.0
Design	2x type A
Transfer rate	Low speed (1.5 Mbit/s), full speed (12 Mbit/s), high speed (30 Mbit/s)
Current-carrying capacity	Total max. 1 A
SDL3 In	
Design	Shielded RJ45
Type	SDL3
Electrical characteristics	
Nominal voltage	24 VDC ±25%, SELV ²⁾
Nominal current	Max. 3 A
Overvoltage category per EN 61131-2	II
Electrical isolation	Yes
Operating conditions	
Pollution degree per EN 61131-2	Pollution degree 2

Table 50: 5DLSD3.1001-00 - Technical data

Technical data

Model number	5DLSD3.1001-00
Mechanical characteristics	
Dimensions	
Width	190 mm
Height	110 mm
Depth	23.6 mm
Weight	527 g

Table 50: 5DLSD3.1001-00 - Technical data

- 1) Yes, although applies only if all components installed within the complete system have this certification and the complete system itself carries the corresponding mark.
- 2) EN 60950 requirements must be observed, see section "+24 VDC power supply" in the user's manual.

2.3.2.3 5DLSD4.1001-00

2.3.2.3.1 General information

- Link module for Automation Panel 9x3/1000/5000
- 1x SDL4 Panel In interface
- 2x USB 2.0 type A

2.3.2.3.2 Order data

Model number	Short description	Figure
	Link modules	
5DLSD4.1001-00	Automation Panel link module - SDL4 receiver - For Automation Panel 923/933/1000 - For Automation Panel 5000	
	Required accessories	
	Terminal blocks	
0TB103.9	Connector 24 VDC - 3-pin female - Screw clamp terminal block 3.31 mm ²	
0TB103.91	Connector 24 VDC - 3-pin female - Cage clamp terminal block 3.31 mm ²	
	Optional accessories	
	SDL3/SDL4 cables	
5CASD3.0030-00	SDL3/SDL4 cable - 3 m	
5CASD3.0050-00	SDL3/SDL4 cable - 5 m	
5CASD3.0100-00	SDL3/SDL4 cable - 10 m	
5CASD3.0150-00	SDL3/SDL4 cable - 15 m	
5CASD3.0200-00	SDL3/SDL4 cable - 20 m	
5CASD3.0300-00	SDL3/SDL4 cable - 30 m	
5CASD3.0500-00	SDL3/SDL4 cable - 50 m	
5CASD3.1000-00	SDL3/SDL4 cable - 100 m	

Table 51: 5DLSD4.1001-00 - Order data

2.3.2.3.3 Technical data

Information:

The following specifications, properties and limit values apply only to this individual component and may deviate from those that apply to the complete system. For the complete system in which this individual component is used, for example, the data specified for that complete system applies.

Model number	5DLSD4.1001-00
General information	
LED status indicators	Status, Link
B&R ID code	0xECE3
Certifications	
CE	Yes
Interfaces	
USB	
Quantity	2
Type	USB 2.0
Design	2x type A
Transfer rate	Low speed (1.5 Mbit/s), full speed (12 Mbit/s), high speed (150 Mbit/s)
Current-carrying capacity	Total max. 1 A
SDL4 In	
Design	Shielded RJ45
Type	SDL4
Electrical characteristics	
Nominal voltage	24 VDC ±25%, SELV ¹⁾
Nominal current	Max. 3 A
Overvoltage category per EN 61131-2	II
Electrical isolation	Yes
Operating conditions	
Pollution degree per EN 61131-2	Pollution degree 2
Mechanical characteristics	
Dimensions	
Width	190 mm
Height	110 mm
Depth	23.6 mm
Weight	525 g

Table 52: 5DLSD4.1001-00 - Technical data

1) EN 60950 requirements must be observed; see section "+24 VDC power supply" of the user's manual.

3 Commissioning

3.1 Installation

Danger!

- All power supplies must be disconnected before removing device covers or components and installing/removing accessories, hardware or cables.
- The power cable must be disconnected from the device and from the power supply.
- All covers, components, accessories, hardware and cables must be installed or connected before the device can be connected to the power supply and switched on.

3.1.1 Important information concerning installation/commissioning

- Checking the delivery
 - When receiving the delivery, check the packaging for any visible transport damage.
 - Any visible transport damage must be documented and reported immediately, or the damage must be confirmed by the shipping/delivery company.
 - Keep the original packaging in the event that goods must be reshipped.

Information:

If a device is transported or stored without packaging, it is unprotected against all environmental factors such as impacts, vibration, pressure, humidity, etc. Damaged packaging indicates that environmental conditions have already heavily affected and possibly damaged the device.

This can result in malfunctions on the device, machine or manufacturing system.

- Check the packaging contents and any ordered accessories for completeness and damage.
- If the packaging contents are incomplete, damaged or do not match your order, your local sales office or B&R headquarters must be informed immediately.

Danger!

A damaged device will operate unpredictably. The unintentional installation or operation of a damaged device must be prevented. The damaged device must be marked as such, removed from the productive environment and sent immediately for repairs.

- The environmental conditions must be observed, see [see "Environmental characteristics"](#).

Caution!

Before the device is put into operation, it must first be acclimated to room temperature! Subjecting it to thermal radiation is not permitted. If transported at low temperatures or if there are large temperature fluctuations, the device is not permitted to be subjected to any type of moisture. Moisture can cause short circuits in the electrical circuits and damages the device.

- The permissible mounting orientation must be observed when installing the device, see [see "Mounting orientations"](#).

Caution!

When installed at an angle, the convection of air through the device is reduced, which decreases the maximum permissible ambient temperature for operation. If sufficient external cooling is present when the device is installed at an angle, the limit of the maximum permissible ambient temperature must be checked in each case. Otherwise, the device can become damaged and the certifications and warranty for the device nullified.

- This device is only certified for operation in enclosed rooms.
- This device is not permitted to be subjected to direct sunlight.
- Ventilation holes are not permitted to be covered.
- When installed in an enclosed housing, sufficient space for air circulation must be present, see [2.2.2.2 "Spacing for air circulation"](#).

Information:

If additional space is needed to operate or service the device, this must be taken into account during installation.

- The device must be installed on a flat, clean and burr-free surface. The IP ratings of the device are only ensured if the following requirements for the surface / installation cutout are met:
 - Permissible deviation from the evenness on the installation cutout: ≤ 0.5 mm.
 - Permissible surface roughness in the area of the mounting seal: ≤ 120 μm (Rz 120).
- It is important to ensure that the wall or control cabinet can withstand four times the total weight of the device. If necessary, the interior of the installation cutout must be reinforced in order to strengthen the installation surface. The IP ratings of the device are only ensured if the following requirements for the installation surface / installation cutout are met:
 - Material thickness of installation cutout: min. 2 mm

Caution!

In the event of insufficient load-carrying capacity of the installation surface, inadequate mounting or improper mounting materials, the device may fall and become damaged.

- The device is not permitted to be positioned next to other heat sources that could cause overheating.
- When connecting cables (DVI, SDL, USB, etc.), the bend radius must be taken into account.
- The device must be installed in a position that minimizes glare on the screen.
- The device must be installed such that viewing is optimized for the user.
- Loss of seal

Caution!

- **The gasket must be inspected before initial installation, subsequent installation as well as at regular intervals appropriate to the requirements of the operating environment.**
- **Replace the entire device if inspection reveals visible scratches, cracks, collected dirt or excessive wear.**
- **Do not unnecessarily stretch the gasket.**
- **Avoid contact between the gasket and the corners and edges of the frame.**
- **It is important to ensure that the gasket is completely inserted into the installation notch.**
- **The housing components must be fastened using the specified tightening torque.**

Failure to follow these instructions can result in damage to property.

3.1.2 Mounting an Automation Panel 1000 with retaining clips

The Automation Panel 1000 is mounted in the cutout using retaining clips. The number of retaining clips depends on the panel.

The following Automation Panel 1000 systems are mounted using retaining clips:

- 5AP1120.0702-I00
- 5AP1125.1043-I00
- 5AP1125.1044-I00
- 5AP1125.1505-I00

The thickness of the wall or cabinet plate must be between 2 mm and 6 mm.

A large flat-blade screwdriver is needed to tighten and loosen the screws. The maximum tightening torque for the retaining clips is 0.5 Nm.

Devices must be installed on a flat, clean and burr-free surface; uneven areas can cause damage to the display when the screws are tightened or the intrusion of dust and water.

Procedure

1. Insert the device into the front of the prepared, burr-free and flat installation cutout. For the dimensions of the installation cutout, see the individual [panels](#).
2. Place the pressure frame (included in delivery) on the B&R device.



3. Install the retaining clips on the device. To do this, insert all retaining clips into the recesses (marked with orange circles) on the device. The number of retaining clips can vary depending on the panel; for the exact number, see the individual [panels](#).

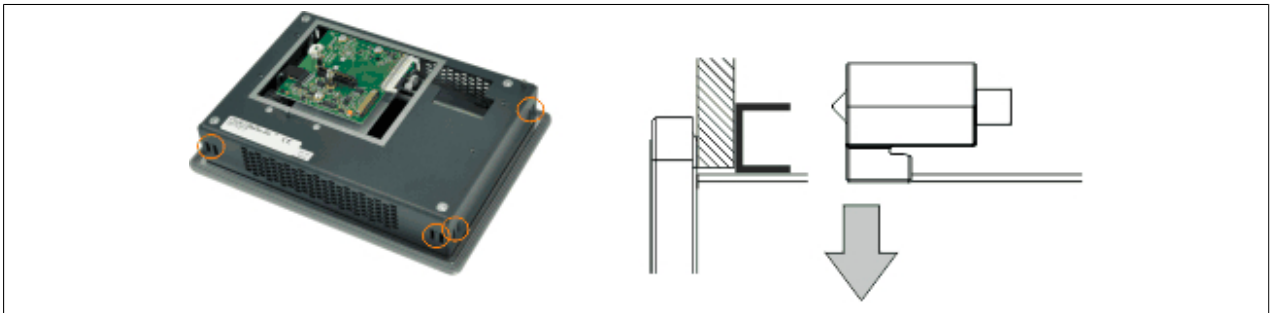

4. Slide the retaining clips all the way to the back of the openings.

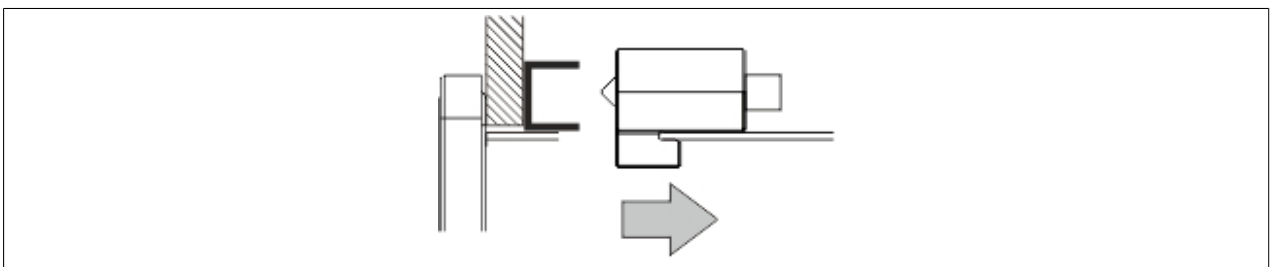

5. Now fasten the retaining clips to the wall or control cabinet by tightening the screws with a flat-blade screwdriver. The tightening torque should be approximately 0.5 Nm.

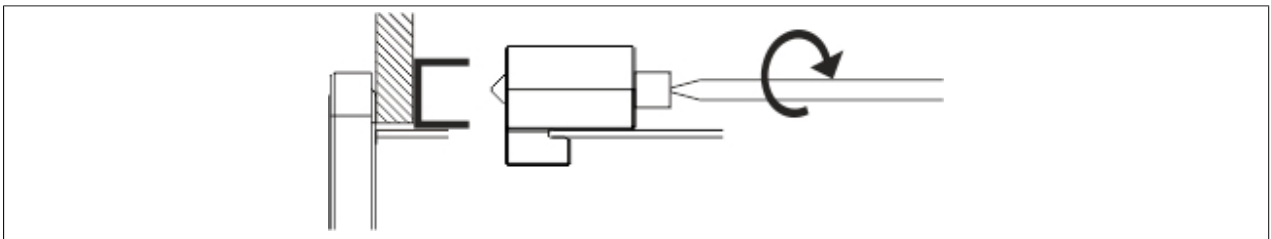

Information:

The retaining clips are designed to clamp material thicknesses up to 6 mm, but mounting using a retaining frame is specified for material thicknesses up to 3 mm.

3.1.3 Replacing link modules

1. Disconnect the power supply to the Automation Panel (disconnect the power cable). Isolate the system from all potential sources of electrical power!
2. Discharge any electrostatic charge on the ground connection.
3. Remove the Automation Panel from the control cabinet by following the installation steps in reverse order.
4. Place the Automation Panel on a clean, flat surface.
5. Remove the Torx screws (T10) indicated in the following image.

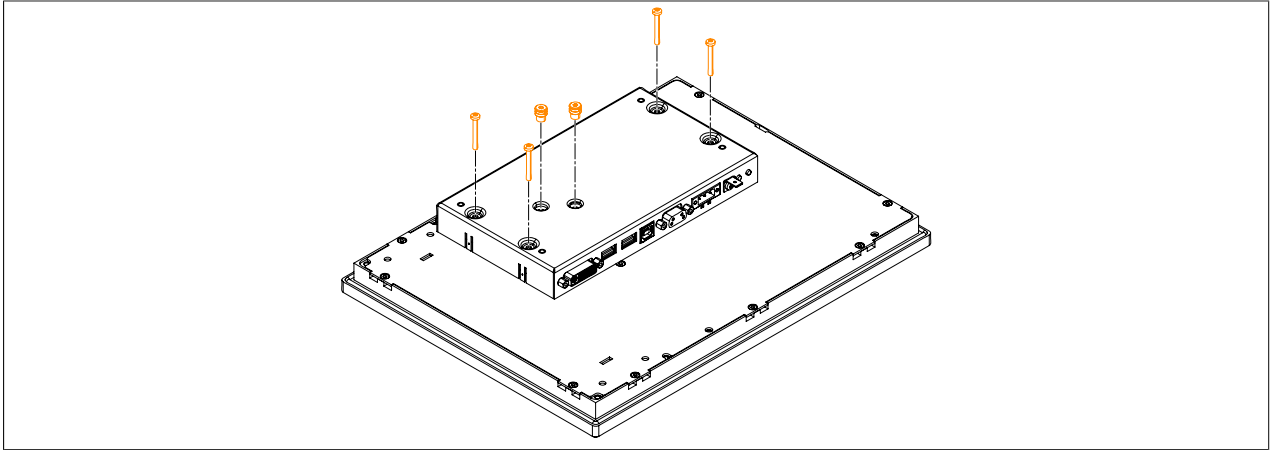

Figure 18: Removing the Torx screws

6. The link module can now be removed by pulling it straight up.

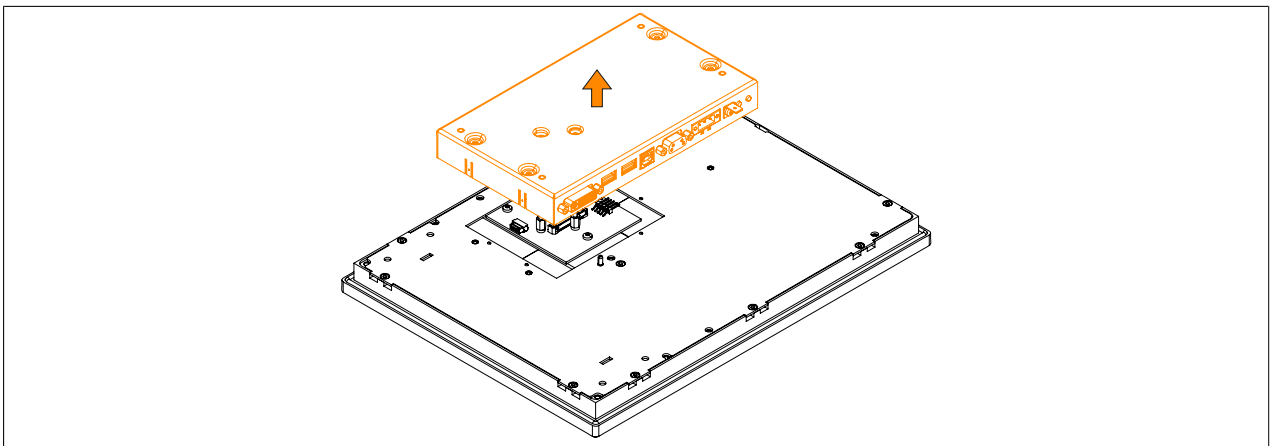

Figure 19: Removing the link module

7. The link module can now be replaced by following these steps in reverse order. The maximum tightening torque of the Torx screws (T10) is 0.5 Nm.

3.2 Connecting to the power grid

Danger!

- All power supplies must be disconnected before removing device covers or components and installing/removing accessories, hardware or cables.
- The power cable must be disconnected from the device and from the power supply.
- All covers, components, accessories, hardware and cables must be installed or connected before the device can be connected to the power supply and switched on.

3.2.1 Installing the DC power cable

Danger!

All power supplies to the B&R industrial PC and B&R Automation Panel must be interrupted. Before connecting the DC power cable, it is necessary to check whether it has been disconnected from the power source (e.g. power supply).

3.2.1.1 Wiring

The DC power cable must be installed in the terminal block (power supply connector) as shown in the image below. Wires with a cross section of 0.75 mm² to 1.5 mm² and wire end sleeves must be used.

Installing screw clamp terminal block 0TB103.9

Fasten the wires with wire end sleeves into the terminal contacts ② as shown in the image below and tighten the screw clamp terminals ① with a screwdriver (max. tightening torque 0.4 Nm).

Observe the pinout of the power supply connection on the device during wiring!

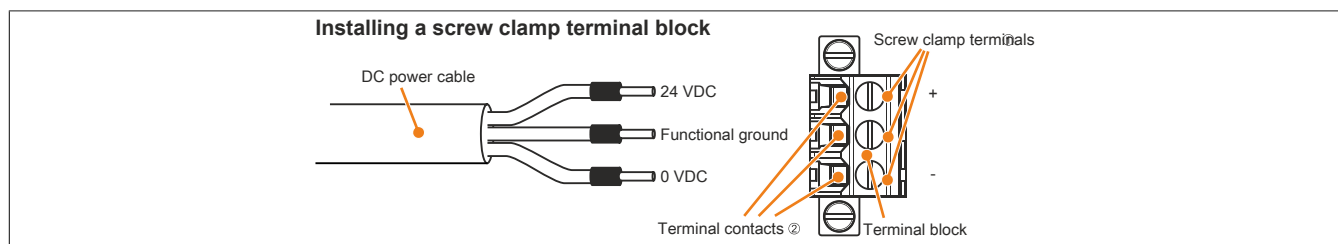

Figure 20: Installing a screw clamp terminal block

Installing cage clamp terminal block 0TB103.91

Insert a screwdriver into the cage clamp terminals ① and secure the wires with wire end sleeves in the terminal contacts ② as shown in the image below. Close the terminal contact by removing the screwdriver.

Observe the pinout of the power supply connection on the device during wiring!

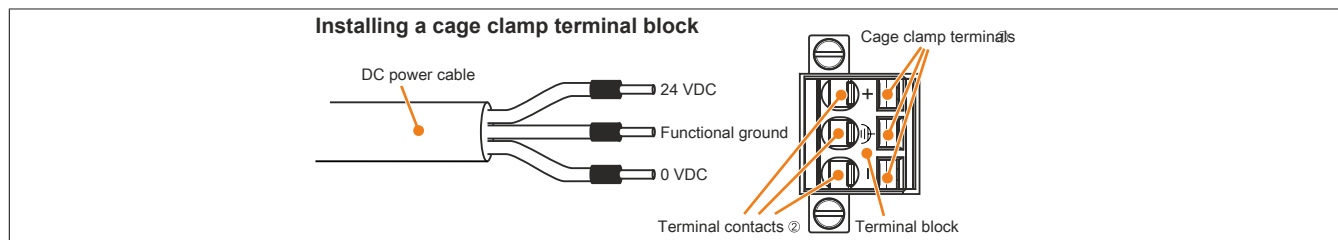

Figure 21: Installing a cage clamp terminal block

3.2.2 Connecting the power supply to a B&R device

Danger!

The power supply to the B&R device must be completely interrupted. Before connecting the power cable, it is necessary to check whether it has been disconnected from the power source (e.g. power supply).

1. Discharge any electrostatic charge on the housing or ground connection.
2. Connect the power supply connector to the B&R device and tighten the mounting screws (max. tightening torque 0.5 Nm).

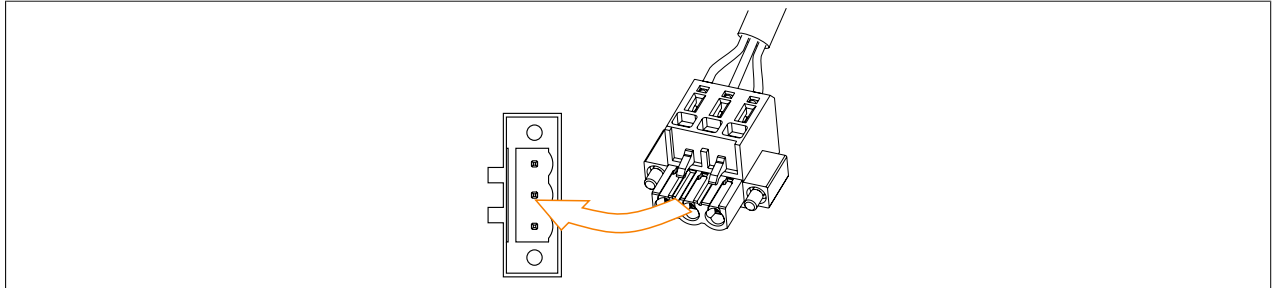

Figure 22: Connecting the power supply connector to a B&R device

3.2.3 Functional ground - Grounding concept

Functional ground is a current path of low impedance between electrical circuits and ground. It is used to improve immunity to interference, for example, and not necessarily as a protective measure. It therefore serves only to conduct interference, not to provide any kind of protection against electric shock.

This device comes equipped with 2 functional ground connections:

- Power supply
- Ground connection

To ensure the safe conductance of electrical interference, the following points must be observed:

- The device must be connected to the central grounding point in the control cabinet using the shortest route possible.
- A cable with a minimum cross section of 2.5 mm^2 per connection must be used. If a cable with wire end sleeves is connected to terminal block 0TB103.9 or 0TB103.91, then a cable with maximum 1.5 mm^2 per connection is possible.
- Observe the line shielding concept. All data cables connected to the device must be shielded.

The following symbol is used to indicate functional ground on the B&R device: 

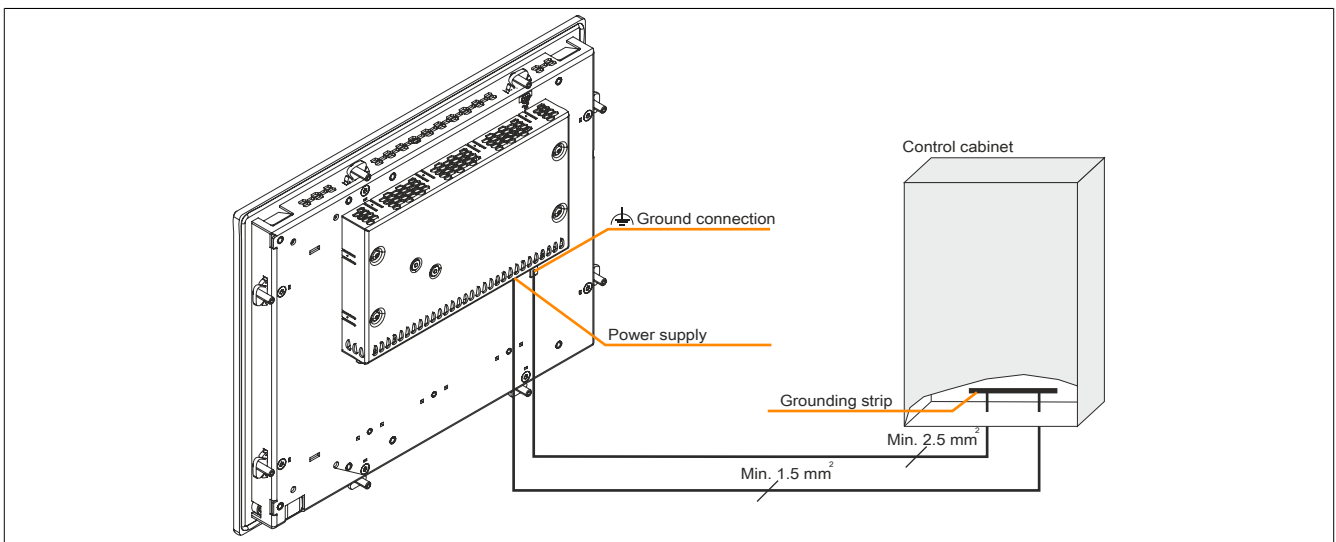

Figure 23: Automation Panel 1000 - Grounding concept

3.3 Cable connections

The bend radius specifications must be taken into account when installing or connecting cables.

Information:

The maximum tightening torque for the locating screws is 0.5 Nm.

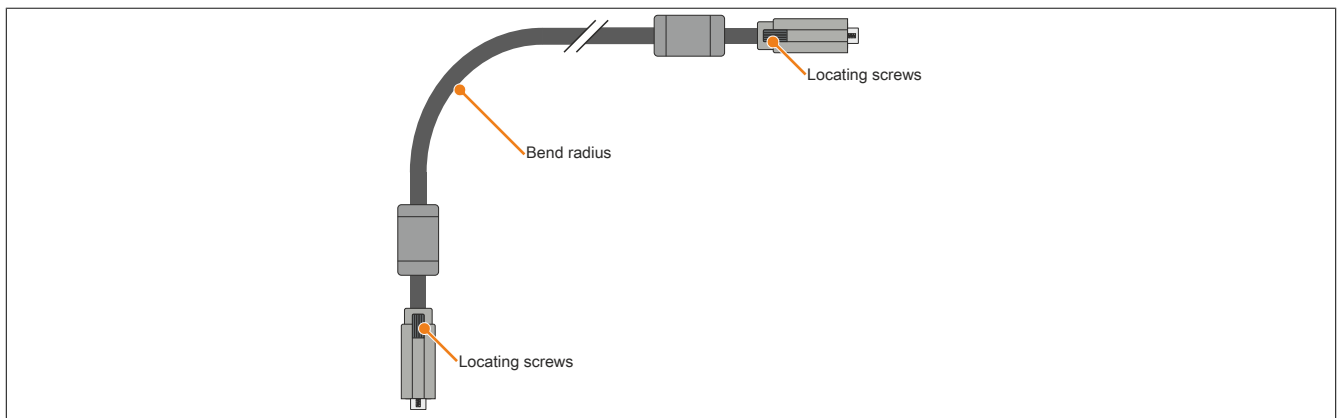

Figure 24: Bend radius - Cable connection

Information:

For the specified bend radius, see the technical data for the respective cable.

3.4 Switching on the device for the first time

3.4.1 General information before switching on the device

Checklist

The following items must be checked before the device is put into service for the first time:

- Have the installation notes specified in "Installation" on page 60 been observed?
- Have the permissible environmental conditions for the device been taken into account?
- Is the power supply connected correctly, and have the values been checked?
- Is the ground cable connected correctly to the ground connection?
- The device must first be put into service before additional hardware is installed.

Caution!

Before the device is put into service, it must slowly be acclimated to room temperature! Subjecting it to thermal radiation is not permitted.

If transported at low temperatures or if there are large temperature fluctuations, the device is not permitted to be subjected to any type of moisture.

Moisture can cause short circuits in the electrical circuits and damages the device.

Requirements

The following requirements must be fulfilled before the device is switched on for the first time:

- The protective film has been removed from the panel.
- The functional ground connections must be kept as short as possible and connected to the central grounding point using the largest possible wire cross section.
- All connection cables must be connected correctly.
- A USB keyboard and USB mouse are connected (optional).
- An Automation PC or Panel PC is connected (via DVI, SDL, SDL3 or SDL4).

3.4.2 Switching on the Automation Panel

Procedure

1. Connect and switch on the voltage supply (e.g. power supply).
2. The device is operational.

3.5 Touch screen calibration

B&R touch screen devices are equipped with a B&R touch controller that supports hardware calibration. This means that devices are pre-calibrated when delivered. This is a beneficial property when replacing devices of the same model or type since the new device does not require recalibration. Nevertheless, calibrating the device is still recommended in order to achieve the best results and to better adapt the touch screen to the user's preferences.

3.5.1 Single-touch (analog resistive)

3.5.1.1 Windows Embedded 8.1 Industry Pro

After starting Windows Embedded 8.1 Industry Pro on the Panel PC for the first time, the corresponding touch screen driver is installed automatically.

On all other devices, the touch screen driver must be subsequently installed to operate the touch screen. The appropriate driver is available for download in the Downloads section of the B&R website (www.br-automation.com).

3.5.1.2 Windows 7 Professional / Ultimate

After installing Windows 7 on the device, the touch screen driver must be installed in order to operate the touch screen. The appropriate driver is available for download in the Downloads section of the B&R website (www.br-automation.com).

3.5.1.3 Windows Embedded Standard 7 Embedded / Premium

A touch screen driver will be installed automatically if a touch controller is detected during the Windows Embedded Standard 7 installation.

The touch screen driver must be installed manually if a touch controller was not detected when installing Windows Embedded Standard 7 or if an Automation Panel has been connected after installation. The appropriate driver is available for download in the Downloads section of the B&R website (www.br-automation.com).

3.5.1.4 Windows XP Professional

After installing Windows XP Professional on the device, the touch screen driver must be installed in order to operate the touch screen. The appropriate driver is available for download in the Downloads section of the B&R website (www.br-automation.com).

3.5.1.5 Windows Embedded Standard 2009

After starting Windows Embedded Standard 2009 on the Panel PC or Power Panel for the first time (first boot agent), the corresponding touch screen driver is installed automatically.

On all other devices, the touch screen driver must be subsequently installed to operate the touch screen. The appropriate driver is available for download in the Downloads section of the B&R website (www.br-automation.com).

3.6 Adjusting the display brightness

In SDL, SDL3 or SDL4 mode, the brightness of the display can be configured using the Control Center on the connected B&R industrial PC, for example. In DVI mode, the brightness can only be controlled using the two brightness controls provided on the SDL/DVI receiver.

3.6.1 Adjusting in SDL / SDL3 / SDL4 mode

1. Open the **Control Center** in the Control Panel.
2. Select the **Display** tab.
3. Select the Automation Panel from the list.
4. Set the desired brightness using the slider control.

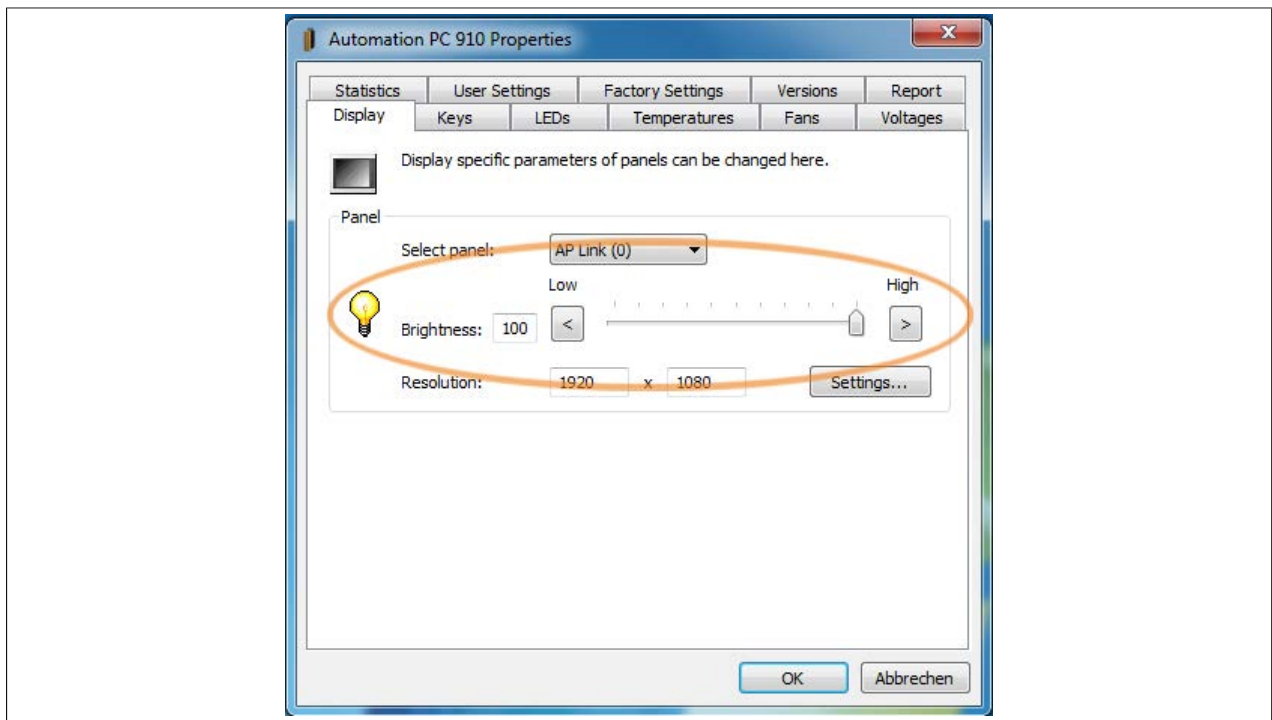

Figure 25: Adjusting the display brightness

Information:

Changes to these settings are displayed online but are only applied by the system (and applied during the next restart) if the Control Center is closed with **OK**.

The configured brightness is separate from the value configured in BIOS Setup, i.e. the value in BIOS is used until Windows boots. The value from BIOS is only applied the first time the Control Center is launched.

3.6.2 Adjusting in DVI mode

1. Use the two brightness controls on the SDL/DVI receiver to set the brightness.

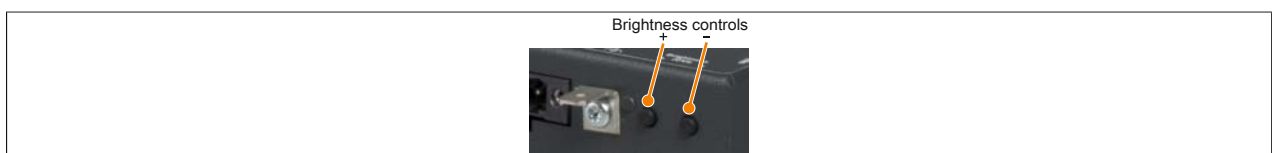

Figure 26: Brightness controls

4 Software

4.1 Upgrade information

Warning!

The BIOS and firmware on B&R devices must be kept current. New versions can be downloaded from the B&R website (www.br-automation.com).

4.1.1 Upgrading the firmware on the Automation Panel

The "Firmware upgrade (Automation Panel, SDL3 Converter)" software makes it possible to update the firmware for multiple controllers (SDLR, SDL3R, SDL4R, SDL3 Converter) depending on how the system is designed.

The latest firmware upgrade is available in the Downloads section of the B&R website (www.br-automation.com).

Caution!

The PC is not permitted to be switched off or reset while performing an update!

4.2 B&R Automation Device Interface (ADI) Control Center

The Automation Device Interface (ADI) makes it possible to access specific functions of B&R devices. In Windows, the settings for these devices can be viewed and modified using the B&R Control Center in the Control Panel.

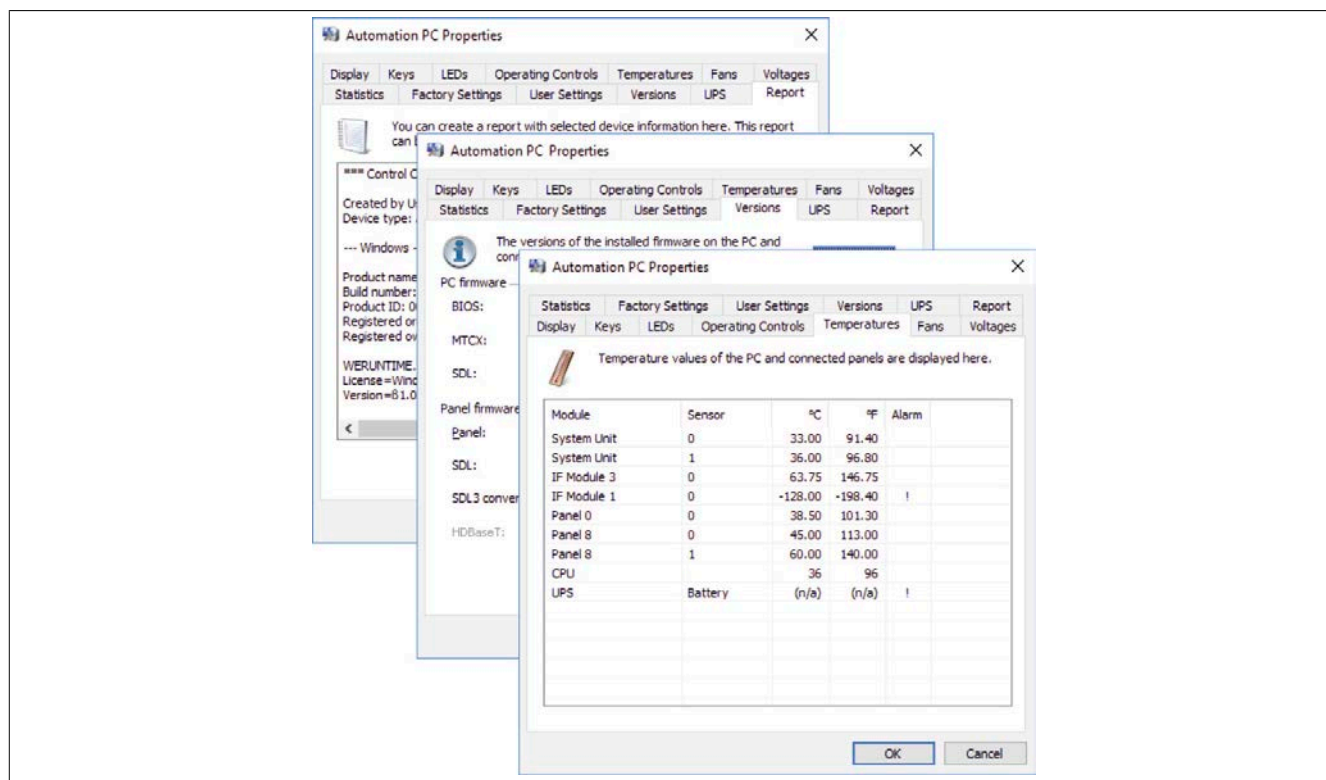

Figure 27: ADI Control Center screenshots - Examples

Information:

The temperature and voltage values (e.g. CPU temperature, core voltage, battery voltage) displayed represent uncalibrated values for informational purposes. They cannot be used to draw conclusions about possible hardware alarms or error states. The hardware components being used include automatic diagnostic functions in the event of error.

4.2.1 Functions

Information:

The functions provided by the Control Center depend on the device family.

- Changing display-specific parameters
- Reading device-specific keys
- Updating the key configuration
- Enabling device-specific LEDs on a membrane keypad or keys
- Reading and calibrating control devices (e.g. key switches, handwheels, joysticks, potentiometers)
- Reading temperatures, fan speeds, statistical data and switch positions
- Reading operating hours (power-on hours)
- Reading user settings and factory settings
- Reading software versions
- Updating and backing up BIOS and firmware
- Creating reports about the current system (support assistance)
- Setting the SDL equalizer value when adjusting SDL cables
- Changing the user serial ID

For a detailed description of the Control Center, see Automation Help or the user documentation (depends on the version).

4.2.2 Installation

The B&R Automation Device Interface (ADI) driver (also includes the Control Center) and user documentation can be downloaded at no cost from the Downloads section of the B&R website (www.br-automation.com).

Information:

The ADI driver is included in most B&R Windows operating systems; it can also be installed on demand.

If a more current ADI driver version exists (see the Downloads section of the B&R website), it can be installed later. Note that the write filter must be disabled during installation.

4.3 B&R Automation Device Interface (ADI) Development Kit

This software can be used to access B&R Automation Device Interface (ADI) functions directly from Windows applications created in Microsoft Visual Studio, for example.

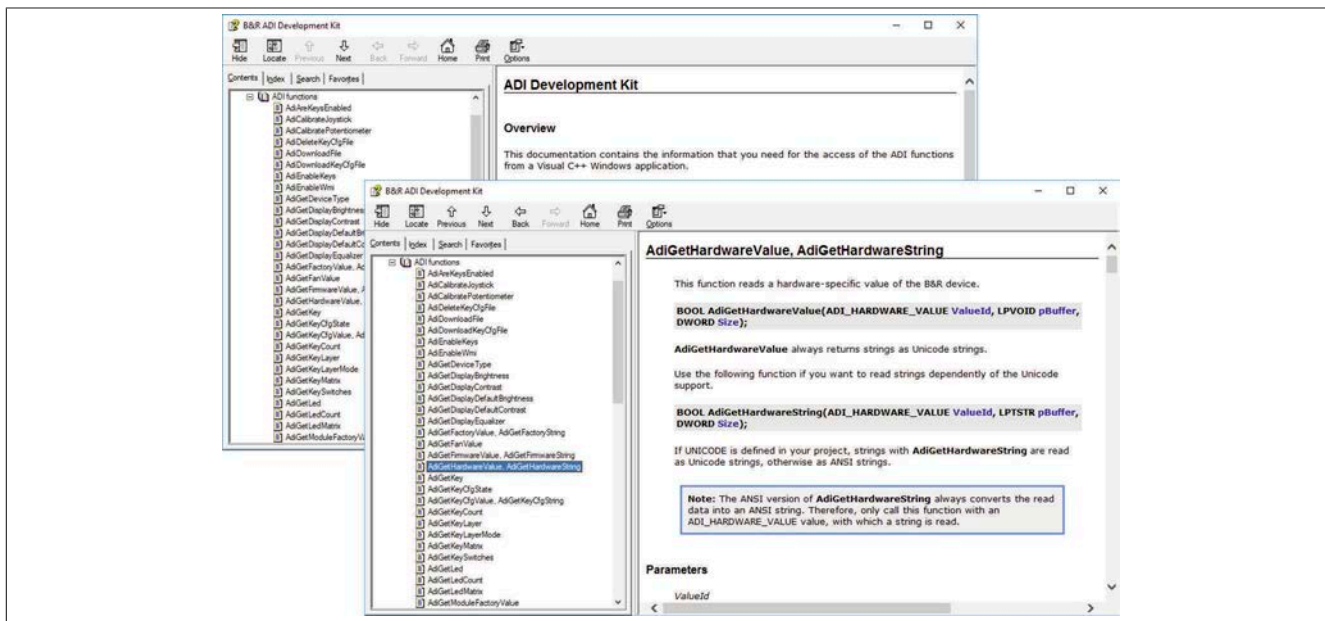

Figure 28: ADI Development Kit Screenshots (Symbolbild)

Features:

- Header files and import libraries
- Help files
- Sample projects
- ADI DLL (for testing applications if no ADI driver is installed)

The appropriate ADI driver must be installed for the specified product family. The ADI driver is already included in the embedded operating system images from B&R.

For a detailed description of how to use ADI functions, see Automation Help.

The B&R Automation Device Interface (ADI) Development Kit can be downloaded at no cost from the Downloads section of the B&R website (www.br-automation.com).

4.4 B&R Automation Device Interface (ADI) .NET SDK

This software can be used to access B&R Automation Device Interface (ADI) functions directly from .NET applications created in Microsoft Visual Studio.

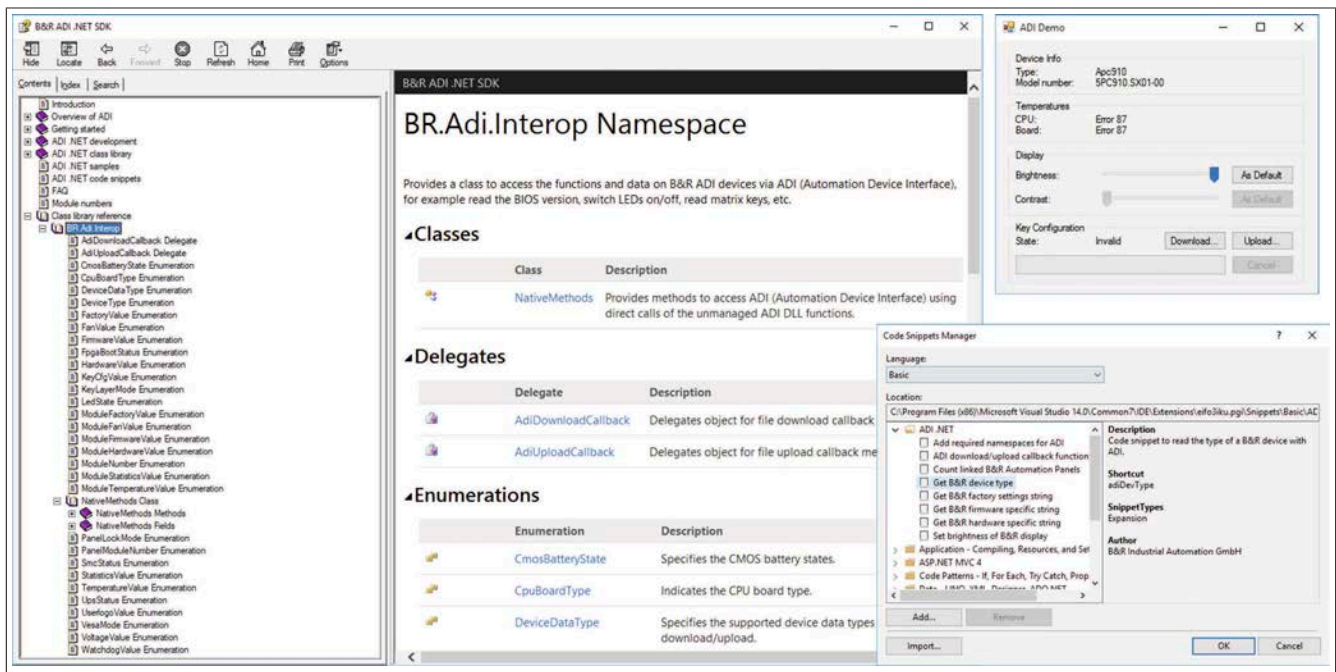

Figure 29: ADI .NET SDK screenshots

Features:

- ADI .NET class library
- Help files (the help documentation is in English)
- Sample projects and code snippets.
- ADI DLL (for testing applications if no ADI driver is installed).

The appropriate ADI driver must be installed for the specified product family. The ADI driver is already included in the embedded operating system images from B&R.

For a detailed description of how to use ADI functions, see Automation Help.

The ADI .NET SDK can be downloaded at no cost from the Downloads section of the B&R website (www.br-automation.com).

5 Standards and certifications

5.1 Standards and guidelines

5.1.1 CE marking



All guidelines applicable to the product and their harmonized EN standards are fulfilled.

5.1.2 EMC directive

These products meet the requirements of EU directive "Electromagnetic compatibility 2014/30/EU" and are designed for industrial use:

EN 61131-2:2007	Programmable logic controllers - Part 2: Equipment requirements and tests
EN 61000-6 -2:2005	Electromagnetic compatibility (EMC) - Part 6-2: Generic standards - Immunity for industrial environments
EN 61000-6 -4:2007	Electromagnetic compatibility (EMC) - Part 6-4: Generic standards - Emission standard for industrial environments

Information:

Declarations of conformity are available on the B&R website under [Downloads - Certificates - Declarations of conformity](#).

5.1.3 Low voltage directive

These devices satisfy the requirements of EC directive "2006/95/EC Low voltage directive" and are designed for the following areas:

EN 61131-2:2007	Programmable logic controllers - Part 2: Equipment requirements and tests
EN 60204-1:2006 + A1:2009	Safety of machinery - Electrical equipment of machines - Part 1: General requirements

The low voltage directive applies to equipment that can be used with a nominal voltage between 50 and 1000 VAC and between 75 and 1500 VDC.

5.2 Certifications

Danger!

A complete system can only receive certification if ALL of the individual components installed therein have the corresponding certifications. If an individual component is used that DOES NOT have a corresponding certification, then the complete system also DOES NOT have certification.

Products and services from B&R comply with applicable standards. This includes international standards from organizations such as ISO, IEC and CENELEC, as well as national standards from organizations such as UL, CSA, FCC, VDE, ÖVE, etc. We are committed to ensuring the reliability of our products in industrial environments.

Information:

Applicable certifications for the respective product are available on the website, under section "Certifications" of the technical data in the user's manual or in the associated certificates.

5.2.1 UL certification



Products with this mark are tested by Underwriters Laboratories and listed as "industrial control equipment". This mark is valid for the USA and Canada and simplifies the certification of your machines and manufacturing systems in this economic region.

Underwriters Laboratories (UL) per standards UL 61010-1 and UL 61010-2-201 Canadian (CSA) standard per C22.2 No. 61010-1-12 and CSA C22.2 No. 61010-2-201:14

Ind.Cont.Eq.
E115267

UL certificates are available on the B&R website under [Downloads - Certificates - UL](#).

It is important to note that the device is classified as "open type" when used in the area of "Industrial control equipment" per UL 61010-1/UL 61010-2-201. The device must therefore be installed in an appropriate protective housing as a requirement for certification or operation per UL 61010-1/UL 61010-2-201.

The front of the device satisfies IP65 (EN 60529) and "Type 4X indoor use only" (UL50E) requirements.

6 Accessories

The functionality of the following accessories has been tested and approved by B&R in connection with this device. Nevertheless, there may be possible limitations with regard to operation with other individual components as part of the complete system. For the operation of the complete system, all individual specifications of the components must be observed.

All components listed in this manual have been subjected to extensive system and compatibility testing and approved accordingly. B&R cannot guarantee the functionality of non-approved accessories.

6.1 Power connectors

6.1.1 0TB103.9x

6.1.1.1 General information

This 1-row, 3-pin 0TB103 terminal block is used for the power supply.

6.1.1.2 Order data

Model number	Short description	Figure
	Accessories	
0TB103.9	Connector 24 VDC - 3-pin female - Screw clamp terminal block 3.31 mm ²	
0TB103.91	Connector 24 VDC - 3-pin female - Cage clamp terminal block 3.31 mm ²	

Table 53: 0TB103.9, 0TB103.91 - Order data

6.1.1.3 Technical data

Information:

The following specifications, properties and limit values apply only to this accessory and may deviate from those that apply to the complete system. For the complete system in which this accessory is installed, for example, the data specified for that complete system applies.

Model number	0TB103.9	0TB103.91
General information		
Certification	Yes	
CE	cULus E115267	
UL	Industrial control equipment	
HazLoc	cULus HazLoc E180196 Industrial control equipment for hazardous locations	
DNV GL	Class I, Division 2, Groups ABCD, T4 ¹⁾ Temperature: B (0 - 55°C) Humidity: B (up to 100%) Vibration: A (0.7 g) EMC: B (Bridge and open deck) ²⁾	
Terminal block		
Note	Protected against vibration by the screw flange Nominal values per UL	
Number of pins	3 (female)	
Type of terminal block	Screw clamp terminal block	Cage clamp terminal block ³⁾
Cable type	Only copper wires (no aluminum wires!)	
Distance between contacts	5.08 mm	

Table 54: 0TB103.9, 0TB103.91 - Technical data

Model number	0TB103.9	0TB103.91
Connection cross section		
AWG wire	26 to 14 AWG	26 to 12 AWG
Wire end sleeves with plastic covering		0.20 to 1.50 mm ²
Solid wires		0.20 to 2.50 mm ²
Fine strand wires	0.20 to 1.50 mm ²	0.20 to 2.50 mm ²
With wire end sleeves		0.20 to 1.50 mm ²
Tightening torque	0.4 Nm	-
Electrical characteristics		
Nominal voltage		300 V
Nominal current ⁴⁾		10 A / contact
Contact resistance		≤5 mΩ
Operating conditions		
EN 61131 pollution degree		Pollution degree 2

Table 54: 0TB103.9, 0TB103.91 - Technical data

- 1) Yes, although applies only if all components installed in the complete system have this certification and the complete system bears the corresponding mark.
- 2) Yes, although applies only if all components installed in the complete system have this certification and are listed on the associated DNV GL certificate for the product family.
- 3) Cage clamp terminal blocks cannot be used side-by-side.
- 4) The respective limit data for the I/O modules must be taken into account.

6.2 USB flash drives

6.2.1 5MMUSB.xxxx-01

6.2.1.1 General information

USB flash drives are easily exchangeable data storage devices. Because of their high-speed data transfer (USB 2.0), USB flash drives are ideal for use as portable storage media. Without requiring additional drivers ("Hot Plug & Play"), the USB flash drive becomes an additional drive where data can be read or written.

Information:

Due to the large number of USB flash drives available on the market as well as their short product lifecycle, we reserve the right to provide alternative products. The following measures may therefore be necessary in order to also boot from these USB flash drives:

- The USB flash drive must be reformatted or in some cases also repartitioned (set partition as active).
- The USB flash drive must be in the first position of the BIOS boot order; alternatively, the IDE controllers can be disabled in BIOS. This can be avoided in most cases if command "fdisk / mbr" is additionally executed on the USB flash drive.

6.2.1.2 Order data

Model number	Short description	Figure
	USB accessories	
5MMUSB.2048-01	USB 2.0 flash drive 2048 MB B&R	
5MMUSB.4096-01	USB 2.0 flash drive 4096 MB B&R	

Table 55: 5MMUSB.2048-01, 5MMUSB.4096-01 - Order data

6.2.1.3 Technical data

Information:

The following specifications, properties and limit values apply only to this accessory and may deviate from those that apply to the complete system. For the complete system in which this accessory is installed, for example, the data specified for that complete system applies.

Model number	5MMUSB.2048-01	5MMUSB.4096-01
General information		
Capacity	2 GB	4 GB
LED status indicators	1 LED (green) ¹⁾	
MTBF	>3,000,000 hours	
Type	USB 1.1, USB 2.0	
Maintenance	None	
Default file system	FAT32	
Certifications		
CE	Yes	
GOST-R	Yes	
Interfaces		
USB		
Type	USB 1.1, USB 2.0	
Connection	To any USB type A interface	
Transfer rate	Low speed (1.5 Mbit/s), full speed (12 Mbit/s), high speed (480 Mbit/s)	
Sequential reading	Full speed max. 1 MB/s, high speed max. 32 MB/s	
Sequential writing	Full speed max. 0.9 MB/s, high speed max. 23 MB/s	
Endurance		
SLC flash	Yes	
Data retention	>10 years	
Data reliability	<1 unrecoverable error per 10 ¹⁴ bits read	
Connection cycles	>1500	

Table 56: 5MMUSB.2048-01, 5MMUSB.4096-01 - Technical data

Model number	5MMUSB.2048-01	5MMUSB.4096-01
Support		
Operating systems		
Windows 10 IoT Enterprise LTSB 64-bit		Yes
Windows Embedded 8.1 Industry Pro 32-bit		Yes
Windows Embedded 8.1 Industry Pro 64-bit		Yes
Windows 7 32-bit		Yes
Windows 7 64-bit		Yes
Windows Embedded Standard 7 32-bit		Yes
Windows Embedded Standard 7 64-bit		Yes
Windows XP Professional		Yes
Windows XP Embedded		Yes
Windows 2000		Yes
Windows CE 5.0		Yes
Windows CE 4.2		Yes
B&R Linux 8		Yes
B&R Linux 9		Yes
Electrical characteristics		
Current consumption	Max. 500 µA in sleep mode, max. 120 mA read/write	
Environmental conditions		
Temperature		
Operation	0 to 70°C	
Storage	-50 to 100°C	
Transport	-50 to 100°C	
Relative humidity		
Operation	85%, non-condensing	
Storage	85%, non-condensing	
Transport	85%, non-condensing	
Vibration		
Operation	20 to 2000 Hz: 20 g (peak)	
Storage	20 to 2000 Hz: 20 g (peak)	
Transport	20 to 2000 Hz: 20 g (peak)	
Shock		
Operation	Max. 1500 g (peak)	
Storage	Max. 1500 g (peak)	
Transport	Max. 1500 g (peak)	
Elevation		
Operation	Max. 3048 m	
Storage	Max. 12192 m	
Transport	Max. 12192 m	
Mechanical characteristics		
Dimensions		
Width	17.97 mm	
Length	67.85 mm	
Height	8.35 mm	

Table 56: 5MMUSB.2048-01, 5MMUSB.4096-01 - Technical data

1) Indicates data transfer (receiving and transmitting).

6.2.1.4 Temperature/Humidity diagram

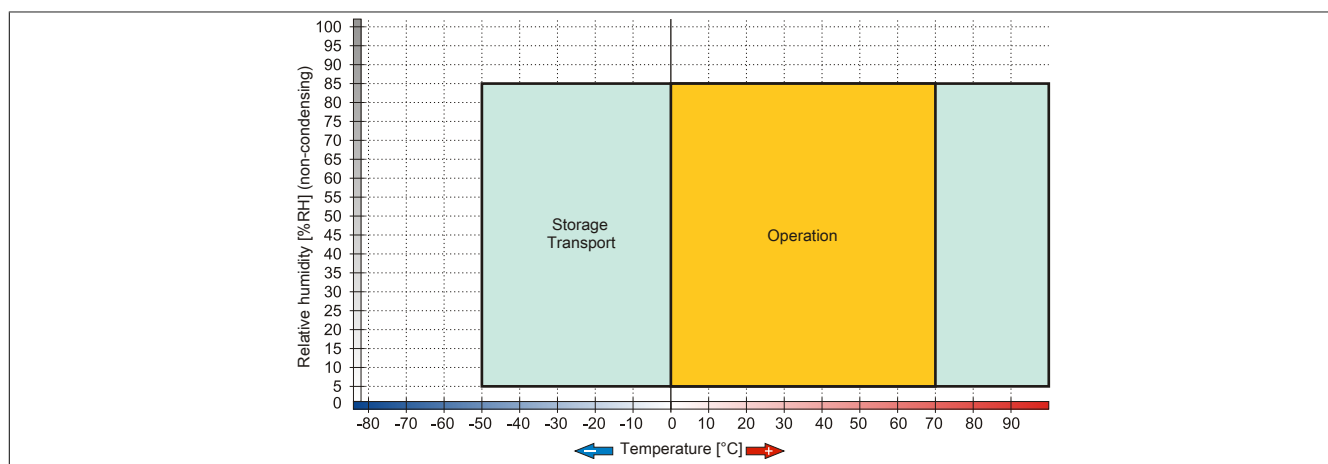

Figure 30: 5MMUSB.xxxx-01 - Temperature/Humidity diagram

6.2.2 5MMUSB.032G-02

6.2.2.1 General information

USB flash drives are easily exchangeable data storage devices. Because of their high-speed data transfer (USB 3.0), USB flash drives are ideal for use as portable storage media. Without requiring additional drivers ("Hot Plug & Play"), the USB flash drive becomes an additional drive where data can be read or written. USB 3.0 (XHCI) is supported starting with Windows 7 (USB 3.0 driver required).

Information:

Due to the large number of USB flash drives available on the market as well as their short product lifecycle, we reserve the right to provide alternative products. The following measures may therefore be necessary in order to also boot from these USB flash drives:

- The USB flash drive must be reformatted or in some cases also repartitioned (set partition as active).
- The USB flash drive must be in the first position of the BIOS boot order; alternatively, the IDE controllers can be disabled in BIOS. This can be avoided in most cases if command "fdisk / mbr" is additionally executed on the USB flash drive.

6.2.2.2 Order data

Model number	Short description	Figure
	USB accessories	
5MMUSB.032G-02	USB 3.0 flash drive 32 GB MLC	

Table 57: 5MMUSB.032G-02 - Order data

6.2.2.3 Technical data

Information:

The following specifications, properties and limit values apply only to this accessory and may deviate from those that apply to the complete system. For the complete system in which this accessory is installed, for example, the data specified for that complete system applies.

Model number	5MMUSB.032G-02
General information	
Capacity	32 GB
LED status indicators	1 LED (green) ¹⁾
MTBF	>3,000,000 hours
Type	USB 2.0, USB 3.0
Maintenance	None
Certifications	
CE	Yes
Interfaces	
USB	
Type	USB 2.0, USB 3.0
Connection	To any USB type A interface
Transfer rate	High speed (480 Mbit/s) to SuperSpeed (4 Gbit/s)
Sequential reading	USB 3.0 max. 100 MB/s
Sequential writing	USB 3.0 max. 50 MB/s
Endurance	
MLC flash	Yes
Data reliability	<1 unrecoverable error per 10 ¹⁴ bits read
Connection cycles	>1500
Electrical characteristics	
Current consumption	Max. 67 mA in sleep mode, max. 122 mA read, max. 141 mA write
Environmental conditions	
Temperature	
Operation	0 to 70°C
Storage	-55 to 95°C
Transport	-55 to 95°C

Table 58: 5MMUSB.032G-02 - Technical data

Model number	5MMUSB.032G-02
Relative humidity	
Operation	10 to 95%, non-condensing
Storage	10 to 95%, non-condensing
Transport	10 to 95%, non-condensing
Vibration	
Operation	7 to 2000 Hz: 20 g
Storage	7 to 2000 Hz: 20 g
Transport	7 to 2000 Hz: 20 g
Shock	
Operation	1500g, 0.5 ms
Storage	1500g, 0.5 ms
Transport	1500g, 0.5 ms
Elevation	
Operation	Max. 3048 m
Storage	Max. 12192 m
Transport	Max. 12192 m
Mechanical characteristics	
Dimensions	
Width	16.58 mm
Length	48.30 mm
Height	7.60 mm
Weight	10 g
Manufacturer information	
Manufacturer	Innodisk
Manufacturer's product ID	DEUA1-32G161BCH88 (USB drive 3ME)

Table 58: 5MMUSB.032G-02 - Technical data

1) Indicates data transfer (receiving and transmitting).

6.2.2.4 Temperature/Humidity diagram

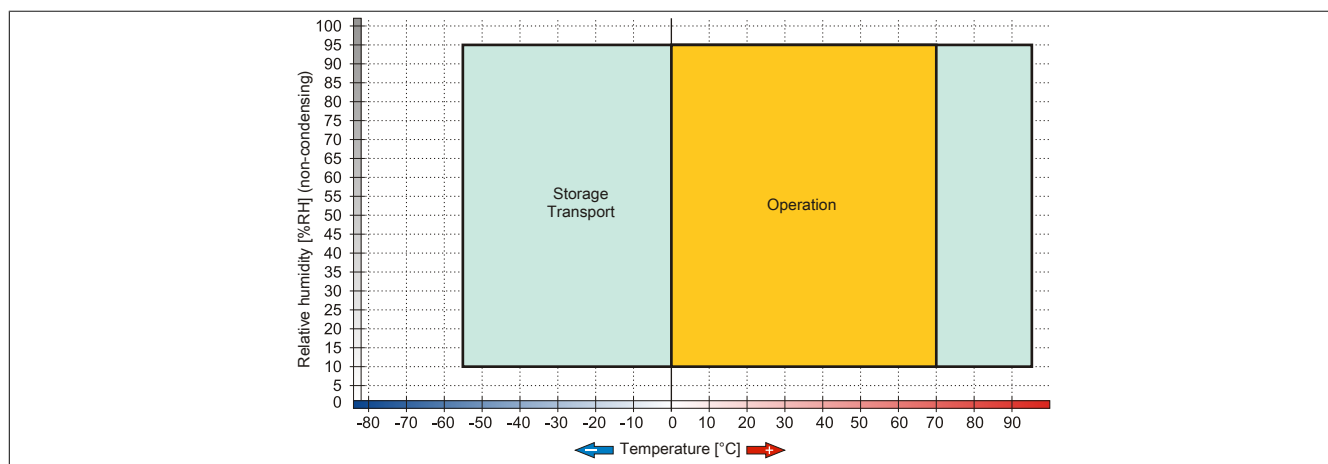

Figure 31: 5MMUSB.032G-02 - Temperature/Humidity diagram

6.3 Cables

6.3.1 DVI cables

6.3.1.1 5CADVI.0xxx-00

6.3.1.1.1 General information

5CADVI.0xxx-00 DVI cables are designed for use in fixed installations.

Caution!

The cable is only permitted to be connected or disconnected when the power is switched off.

6.3.1.1.2 Order data

Model number	Short description	Figure
	DVI cables	
5CADVI.0018-00	DVI-D cable - 1.8 m	
5CADVI.0050-00	DVI-D cable - 5 m	
5CADVI.0100-00	DVI-D cable - 10 m	

Table 59: 5CADVI.0018-00, 5CADVI.0050-00, 5CADVI.0100-00 - Order data

6.3.1.1.3 Technical data

Information:

The following specifications, properties and limit values apply only to this accessory and may deviate from those that apply to the complete system. For the complete system in which this accessory is installed, for example, the data specified for that complete system applies.

Model number	5CADVI.0018-00	5CADVI.0050-00	5CADVI.0100-00
General information			
Certifications			
CE	Yes		
UL	cULus E115267 Industrial control equipment		
DNV GL	Temperature: B (0 - 55°C) Humidity: B (up to 100%) Vibration: A (0.7 g) EMC: B (Bridge and open deck) ¹⁾		
GOST-R	Yes		
Cable construction			
Wire cross section	28 AWG		
Shield	Individual cable pairs, entire cable		
Complete shielding	Tinned copper braiding, optical coverage >86%		
Outer jacket			
Material	PVC		
Color	Beige		
Labeling	AWM STYLE 20276 80°C 30 V VW1 DVI DIGITAL SINGLE LINK DER AN		
Connector			
Type	2x DVI-D (18+1), male		
Connection cycles	100		
Locating screw tightening torque	Max. 0.5 Nm		
Electrical characteristics			
Conductor resistance	Max. 237 Ω/km		
Insulation resistance	Min. 100 MΩ/km		
Operating conditions			
Pollution degree per EN 61131	Pollution degree 2		
Mechanical characteristics			
Dimensions			
Length	1.8 m ±50 mm	5 m ±80 mm	10 m ±100 mm
Diameter	Max. 8.5 mm		
Bend radius	≥5x cable diameter (male connector - ferrite bead and ferrite bead - ferrite bead)		
Weight	Approx. 260 g	Approx. 460 g	Approx. 790 g

Table 60: 5CADVI.0018-00, 5CADVI.0050-00, 5CADVI.0100-00 - Technical data

1) Yes, although applies only if all components installed in the complete system have this certification and are listed on the associated DNV GL certificate for the product family.

6.3.1.1.4 Bend radius specifications

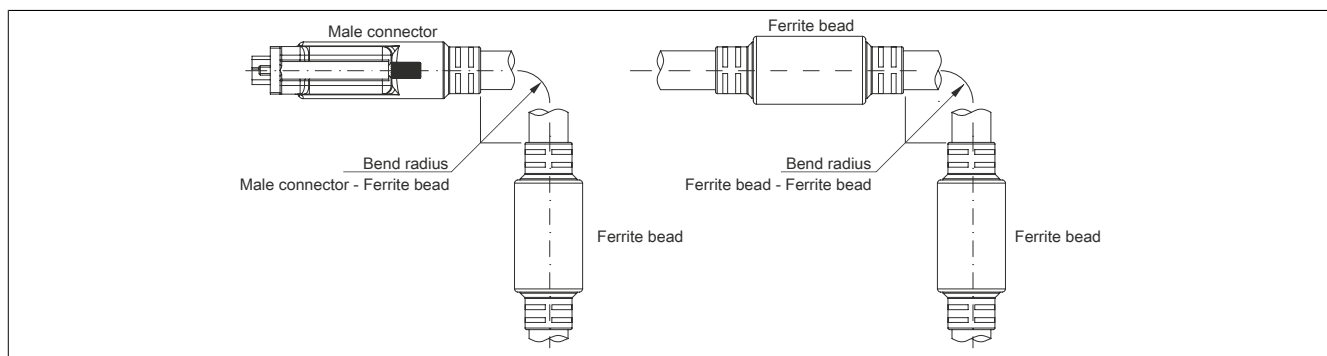

Figure 32: Bend radius specifications

6.3.1.1.5 Dimensions

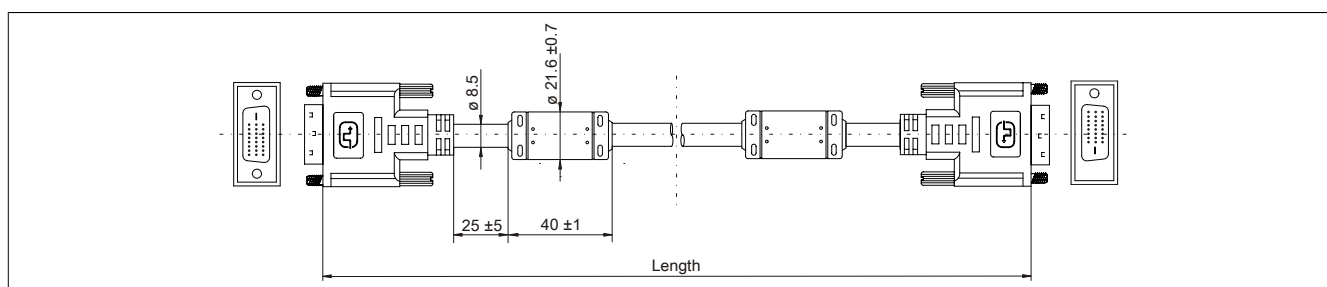

Figure 33: 5CADVI.0xxx-00 - Dimensions

6.3.1.1.6 Cable pinout

Warning!

If a field-assembled cable is desired, it must be wired according to this pinout.

If a field-assembled cable is used, B&R cannot make any guarantee as to its functionality. Functionality is only ensured with cables provided by B&R.

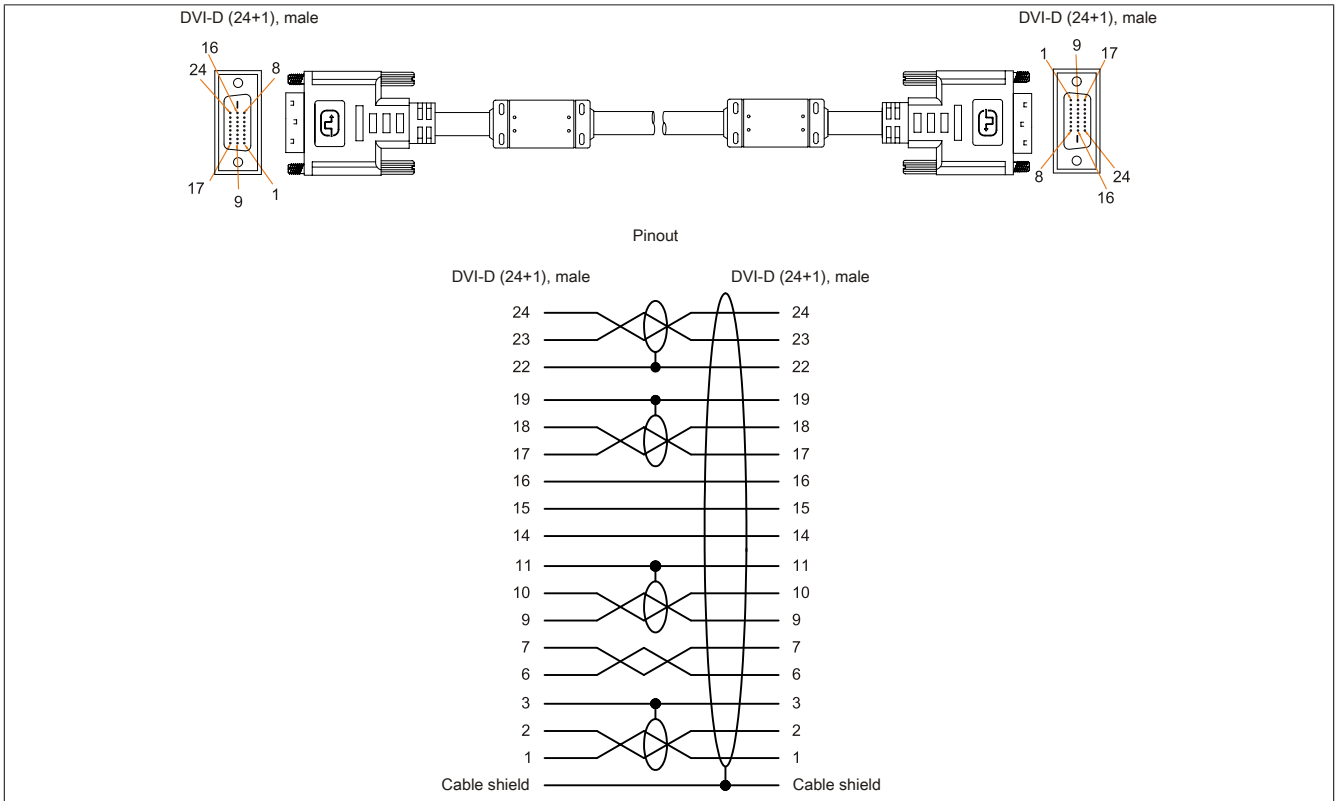

Figure 34: 5CADVI.0xxx-00 - Pinout

6.3.2 SDL cables

6.3.2.1 5CASDL.0xxx-00

6.3.2.1.1 General information

5CASDL.0xxx-00 SDL cables are designed for use in fixed installations. 5CASDL.0xxx-03 SDL flex cables are required for flexible installations (e.g. swing arm systems).

Caution!

The cable is only permitted to be connected or disconnected when the power is switched off.

6.3.2.1.2 Order data

Model number	Short description	Figure
	SDL cables	
5CASDL.0008-00	SDL cable - 0.8 m	
5CASDL.0018-00	SDL cable - 1.8 m	
5CASDL.0050-00	SDL cable - 5 m	
5CASDL.0100-00	SDL cable - 10 m	
5CASDL.0150-00	SDL cable - 15 m	
5CASDL.0200-00	SDL cable - 20 m	
5CASDL.0250-00	SDL cable - 25 m	
5CASDL.0300-00	SDL cable - 30 m	

Table 61: 5CASDL.0008-00, 5CASDL.0018-00, 5CASDL.0050-00, 5CASDL.0100-00, 5CASDL.0150-00, 5CASDL.0200-00, 5CASDL.0250-00, 5CASDL.0300-00 - Order data

6.3.2.1.3 Technical data

Information:

The following specifications, properties and limit values apply only to this accessory and may deviate from those that apply to the complete system. For the complete system in which this accessory is installed, for example, the data specified for that complete system applies.

Model number	5CASDL.0008-00	5CASDL.0018-00	5CASDL.0050-00	5CASDL.0100-00	5CASDL.0150-00	5CASDL.0200-00	5CASDL.0250-00	5CASDL.0300-00
General information								
Certification								
CE	Yes							
UL	cULus E115267 Industrial control equipment							
HazLoc	cULus HazLoc E180196 Industrial control equipment for hazardous locations Class I, Division 2, Groups ABCD, T4 ¹⁾							
DNV GL	Temperature: B (0 - 55°C) Humidity: B (up to 100%) Vibration: A (0.7 g) EMC: B (Bridge and open deck) ²⁾							
GOST-R	-	Yes						
Cable construction								
Wire cross section	28 AWG				24 AWG			
Shield	Individual cable pairs, entire cable							
Complete shielding	Tinned copper braiding, optical coverage >85%							
Outer sheathing								
Material	PVC							
Color	Black							
Labeling	E74020-C (UL) AWM STYLE 20176 80°C 30 V VW-1 DVI DIGITAL LINK							
Connector								
Type	2x DVI-D (24+1), male							
Connection cycles	100							
Contacts	Gold-plated							
Mechanical protection	Metal cover with crimped strain relief							
Locating screw tightening torque	Max. 0.5 Nm							
Electrical characteristics								
Conductor resistance								
24 AWG	-				≤93 Ω/km			
28 AWG	≤237 Ω/km				-			

Table 62: 5CASDL.0008-00, 5CASDL.0018-00, 5CASDL.0050-00, 5CASDL.0100-00, 5CASDL.0150-00, 5CASDL.0200-00, 5CASDL.0250-00, 5CASDL.0300-00 - Technical data

Accessories

Model number	5CASDL.0008-00	5CASDL.0018-00	5CASDL.0050-00	5CASDL.0100-00	5CASDL.0150-00	5CASDL.0200-00	5CASDL.0250-00	5CASDL.0300-00
Insulation resistance	Min. 10 MΩ/km							
Operating conditions								
EN 61131 pollution degree	Pollution degree 2							
Mechanical characteristics								
Dimensions								
Length	0.8 m ±25 mm	1.8 m ±30 mm	5 m ±30 mm	10 m ±50 mm	15 m ±100 mm	20 m ±100 mm	25 m ±100 mm	30 m ±100 mm
Diameter	Typ. 8.6 ±0.2 mm Max. 9 mm			Typ. 11 ±0.2 mm Max. 11.5 mm				
Bend radius	≥5x cable diameter (male connector - ferrite bead and ferrite bead - ferrite bead)							
Flexibility	Limited flexibility, valid for ferrite bead - ferrite bead (tested 100 cycles with 5x cable diameter, 20 cycles/minute)							
Weight	Approx. 206 g	Approx. 300 g	Approx. 580 g	Approx. 1500 g	Approx. 2250 g	Approx. 2880 g	Approx. 4800 g	Approx. 5520 g

Table 62: 5CASDL.0008-00, 5CASDL.0018-00, 5CASDL.0050-00, 5CASDL.0100-00, 5CASDL.0150-00, 5CASDL.0200-00, 5CASDL.0250-00, 5CASDL.0300-00 - Technical data

- 1) Yes, although applies only if all components installed in the complete system have this certification and the complete system bears the corresponding mark.
- 2) Yes, although applies only if all components installed in the complete system have this certification and are listed on the associated DNV GL certificate for the product family.

6.3.2.1.4 Bend radius specifications

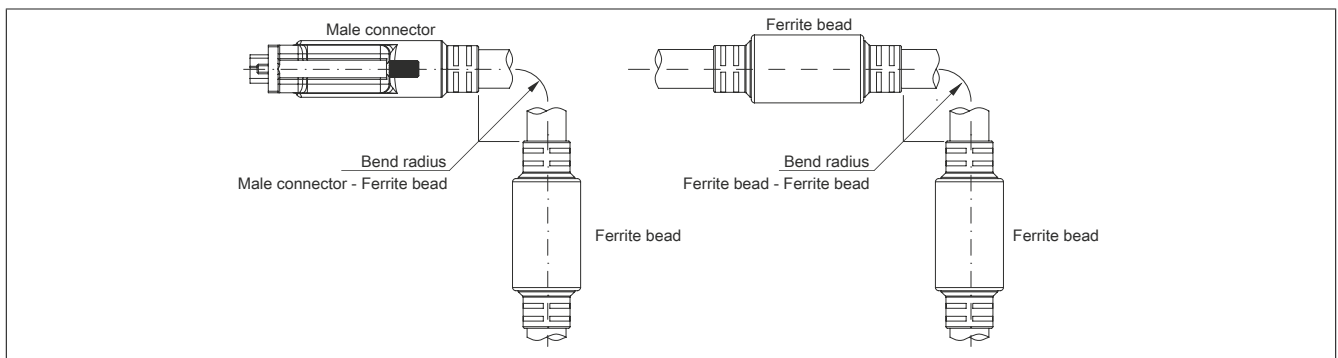

Figure 35: Bend radius specifications

6.3.2.1.5 Dimensions

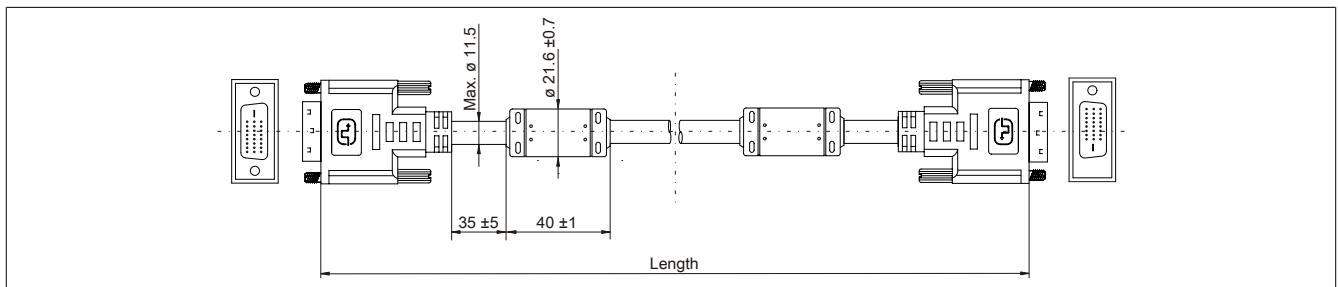

Figure 36: 5CASDL.0xxx-00 - Dimensions

6.3.2.1.6 Cable pinout

Warning!

If a field-assembled cable is desired, it must be wired according to this pinout.

If a field-assembled cable is used, B&R cannot make any guarantee as to its functionality. Functionality is only ensured with cables provided by B&R.

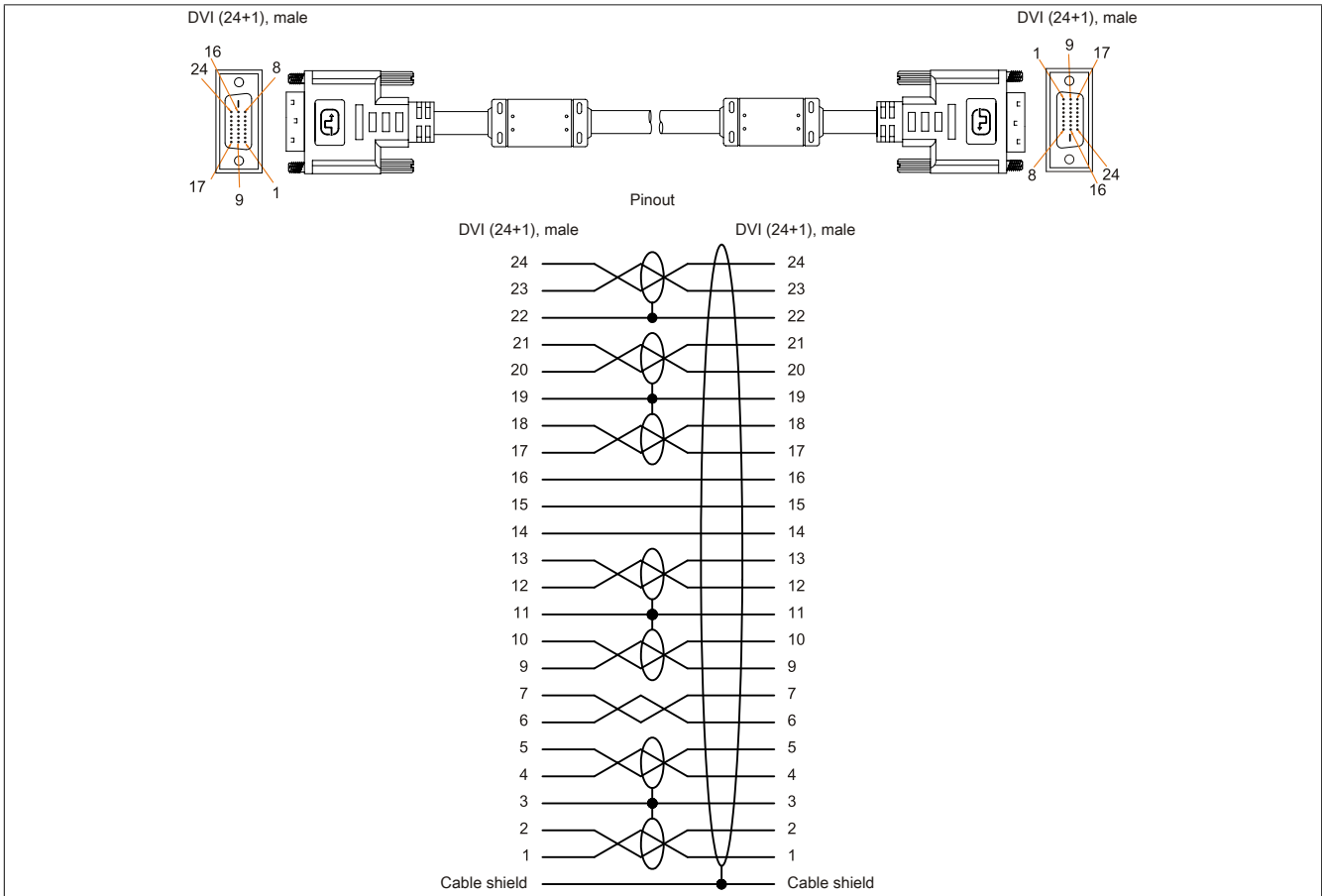

Figure 37: 5CASDL.0xxx-00 - Pinout

6.3.3 SDL cables with 45° male connector

6.3.3.1 5CASDL.0xxx-01

6.3.3.1.1 General information

5CASDL.0xxx-01 SDL cables with 45° connector are designed for use in fixed installations.

Caution!

The cable is only permitted to be connected or disconnected when the power is switched off.

6.3.3.1.2 Order data

Model number	Short description	Figure
	SDL cables 45° connection	
5CASDL.0018-01	SDL cable - 45 degree connector - 1.8 m	
5CASDL.0050-01	SDL cable - 45 degree connector - 5 m	
5CASDL.0100-01	SDL cable - 45 degree connector - 10 m	
5CASDL.0150-01	SDL cable - 45 degree connector - 15 m	

Table 63: 5CASDL.0018-01, 5CASDL.0050-01, 5CASDL.0100-01, 5CASDL.0150-01 - Order data

6.3.3.1.3 Technical data

Information:

The following specifications, properties and limit values apply only to this accessory and may deviate from those that apply to the complete system. For the complete system in which this accessory is installed, for example, the data specified for that complete system applies.

Model number	5CASDL.0018-01	5CASDL.0050-01	5CASDL.0100-01	5CASDL.0150-01
General information				
Certifications				
CE	Yes			
UL	cULus E115267 Industrial control equipment			
HazLoc	cULus HazLoc E180196 Industrial control equipment for hazardous locations			
DNV GL	Class I, Division 2, Groups ABCD, T4 ¹⁾ Temperature: B (0 - 55°C) Humidity: B (up to 100%) Vibration: A (0.7 g)			
GOST-R	EMC: B (Bridge and open deck) ²⁾ Yes			
Cable construction				
Wire cross section	28 AWG		24 AWG	
Shield	Individual cable pairs, entire cable			
Complete shielding	Tinned copper braiding, optical coverage >85%			
Outer jacket				
Material	PVC			
Color	Black			
Connector				
Type	2x DVI-D (24+1), male			
Connection cycles	100			
Contacts	Gold-plated			
Mechanical protection	Metal cover with crimped strain relief			
Locating screw tightening torque	Max. 0.5 Nm			
Electrical characteristics				
Conductor resistance				
24 AWG	-		≤93 Ω/km	
28 AWG	≤237 Ω/km		-	
Insulation resistance	Min. 10 MΩ/km			
Operating conditions				
Pollution degree per EN 61131	Pollution degree 2			
Mechanical characteristics				
Dimensions				
Length	1.8 m ±30 mm	5 m ±50 mm	10 m ±100 mm	15 m ±100 mm
Diameter	Max. 9 mm		Max. 11.5 mm	

Table 64: 5CASDL.0018-01, 5CASDL.0050-01, 5CASDL.0100-01, 5CASDL.0150-01 - Technical data

Model number	5CASDL.0018-01	5CASDL.0050-01	5CASDL.0100-01	5CASDL.0150-01
Bend radius	$\geq 5x$ cable diameter (male connector - ferrite bead and ferrite bead - ferrite bead)			
Fixed installation				
Flexibility	Limited flexibility, valid for ferrite bead - ferrite bead (tested 100 cycles with 5x cable diameter, 20 cycles/minute)			
Weight	Approx. 300 g	Approx. 590 g	Approx. 2800 g	Approx. 2860 g

Table 64: 5CASDL.0018-01, 5CASDL.0050-01, 5CASDL.0100-01, 5CASDL.0150-01 - Technical data

- 1) Yes, although applies only if all components installed in the complete system have this certification and the complete system bears the corresponding mark.
- 2) Yes, although applies only if all components installed in the complete system have this certification and are listed on the associated DNV GL certificate for the product family.

6.3.3.1.4 Bend radius specifications

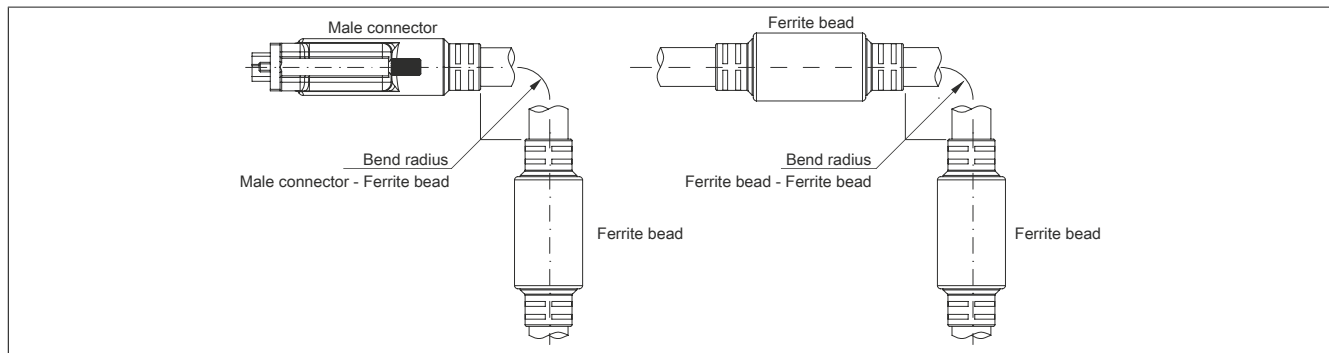

Figure 38: Bend radius specifications

6.3.3.1.5 Dimensions

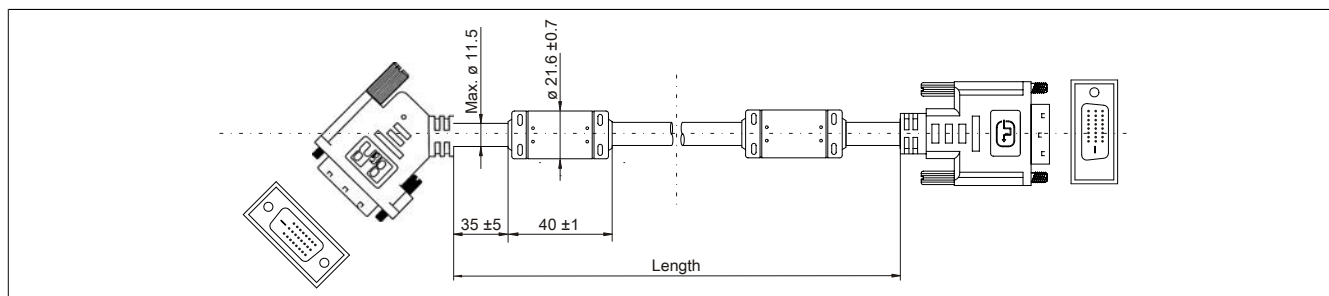

Figure 39: 5CASDL.0xxx-01 - Dimensions

6.3.3.1.6 Cable pinout

Warning!

If a field-assembled cable is desired, it must be wired according to this pinout.

If a field-assembled cable is used, B&R cannot make any guarantee as to its functionality. Functionality is only ensured with cables provided by B&R.

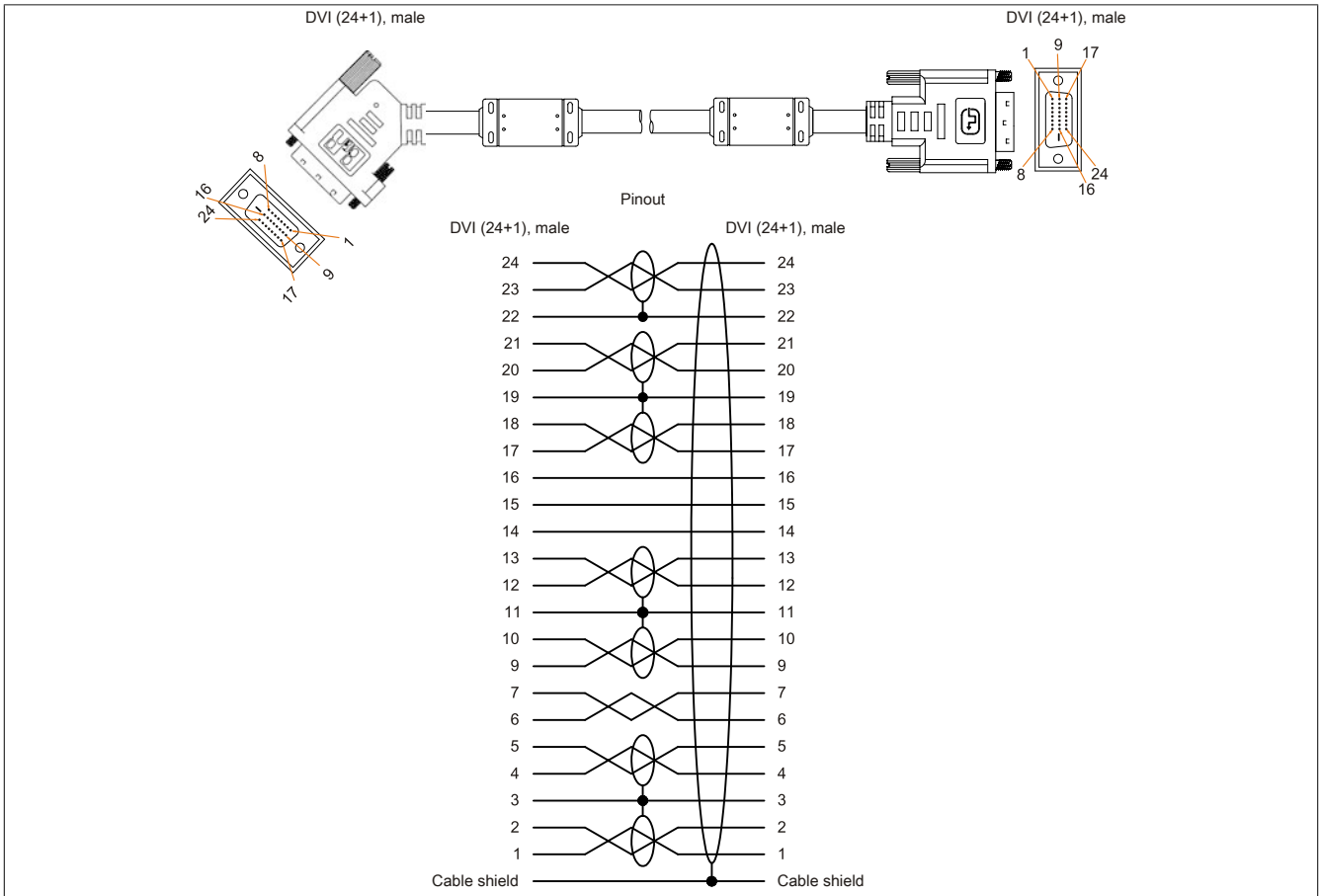

Figure 40: 5CASDL.0xxx-01 - Pinout

6.3.4 SDL flex cables

6.3.4.1 5CASDL.0xxx-03

6.3.4.1.1 General information

5CASDL.0xxx-03 SDL flex cables are designed for use in both fixed and flexible installations (e.g. swing arm systems).

Caution!

The cable is only permitted to be connected or disconnected when the power is switched off.

6.3.4.1.2 Order data

Model number	Short description	Figure
	SDL cables flex	
5CASDL.0018-03	SDL flex cable - 1.8 m	
5CASDL.0050-03	SDL flex cable - 5 m	
5CASDL.0100-03	SDL flex cable - 10 m	
5CASDL.0150-03	SDL flex cable - 15 m	
5CASDL.0200-03	SDL flex cable - 20 m	
5CASDL.0250-03	SDL flex cable - 25 m	
5CASDL.0300-03	SDL flex cable - 30 m	

Table 65: 5CASDL.0018-03, 5CASDL.0050-03, 5CASDL.0100-03, 5CASDL.0150-03, 5CASDL.0200-03, 5CASDL.0250-03, 5CASDL.0300-03 - Order data

6.3.4.1.3 Technical data

Information:

The following specifications, properties and limit values apply only to this accessory and may deviate from those that apply to the complete system. For the complete system in which this accessory is installed, for example, the data specified for that complete system applies.

Model number	5CASDL.0018-03	5CASDL.0050-03	5CASDL.0100-03	5CASDL.0150-03	5CASDL.0200-03	5CASDL.0250-03	5CASDL.0300-03
General information							
Certifications							
CE	Yes						
UL	cULus E115267 Industrial control equipment						
HazLoc	cULus HazLoc E180196 Industrial control equipment for hazardous locations						
DNV GL	Class I, Division 2, Groups ABCD, T4 ¹⁾ Temperature: B (0 - 55°C) Humidity: B (up to 100%) Vibration: A (0.7 g) EMC: B (Bridge and open deck) ²⁾						
GOST-R	Yes						
Cable construction							
Wire cross section	24 AWG (control wires) 26 AWG (DVI, USB, data)						
Properties	Silicone- and halogen-free						
Shield	Individual cable pairs, entire cable						
Complete shielding	Aluminum-clad foil and tinned copper braiding						
Outer jacket							
Material	Special semi-matte TMPU						
Color	Black						
Labeling	(B&R) SDL cable (UL) AWM 20236 80°C 30 V E 63216						
Connector							
Type	2x DVI-D (24+1), male						
Connection cycles	Min. 200						
Contacts	Gold-plated						
Mechanical protection	Metal cover with crimped strain relief						
Locating screw tightening torque	Max. 0.5 Nm						
Electrical characteristics							
Operating voltage	≤30 V						

Table 66: 5CASDL.0018-03, 5CASDL.0050-03, 5CASDL.0100-03, 5CASDL.0150-03, 5CASDL.0200-03, 5CASDL.0250-03, 5CASDL.0300-03 - Technical data

Accessories

Model number	5CASDL.0018-03	5CASDL.0050-03	5CASDL.0100-03	5CASDL.0150-03	5CASDL.0200-03	5CASDL.0250-03	5CASDL.0300-03
Test voltage							
Wire/Wire	1 kV						
Wire/Shield	0.5 kV						
Wave impedance	100 ±10 Ω						
Conductor resistance							
24 AWG	≤95 Ω/km						
26 AWG	≤145 Ω/km						
Insulation resistance	>200 MΩ/km						
Operating conditions							
Pollution degree per EN 61131	Pollution degree 2						
Approbation	UL AWM 20236 80°C 30 V						
Flame-retardant	Per UL 758 (cable vertical flame test)						
Oil and hydrolysis resistance	Per VDE 0282-10						
Environmental conditions							
Temperature							
Storage	-20 to 80°C						
Fixed installation	-20 to 80°C						
Flexible installation	-5 to 60°C						
Mechanical characteristics							
Dimensions							
Length	1.8 m ±20 mm	5 m ±45 mm	10 m ±90 mm	15 m ±135 mm	20 m ±180 mm	25 m ±225 mm	30 m ±270 mm
Diameter	Max. 12 mm						
Bend radius							
Fixed installation	≥3.5x cable diameter						
Flexible installation	≥15x cable diameter (ferrite bead - ferrite bead)						
Flexibility	Flexible, applies to ferrite bead - ferrite bead (tested 300000 cycles with 15x cable diameter, 4800 cycles/hour)						
Drag chain data							
Flex cycles	300,000						
Speed	4800 cycles/hour						
Bend radius	180 mm, 15x cable diameter						
Hub	460 mm						
Weight	Approx. 460 g	Approx. 1020 g	Approx. 1940 g	Approx. 2840 g	Approx. 3740 g	Approx. 4560 g	Approx. 5590 g
Tension							
During operation	≤50 N						
During installation	≤400 N						

Table 66: 5CASDL.0018-03, 5CASDL.0050-03, 5CASDL.0100-03, 5CASDL.0150-03, 5CASDL.0200-03, 5CASDL.0250-03, 5CASDL.0300-03 - Technical data

- 1) Yes, although applies only if all components installed in the complete system have this certification and the complete system bears the corresponding mark.
- 2) Yes, although applies only if all components installed in the complete system have this certification and are listed on the associated DNV GL certificate for the product family.

6.3.4.1.4 Bend radius specifications

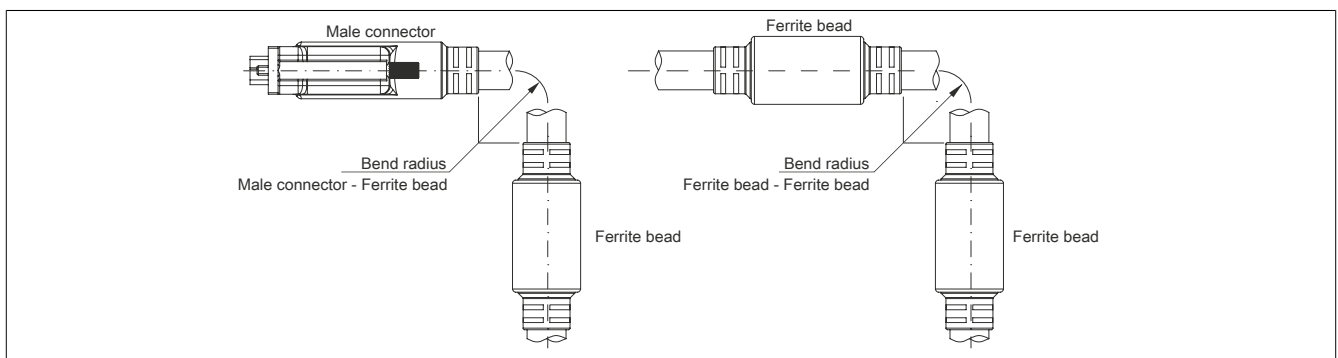

Figure 41: Bend radius specifications

6.3.4.1.5 Dimensions

All dimensions are specified in mm.

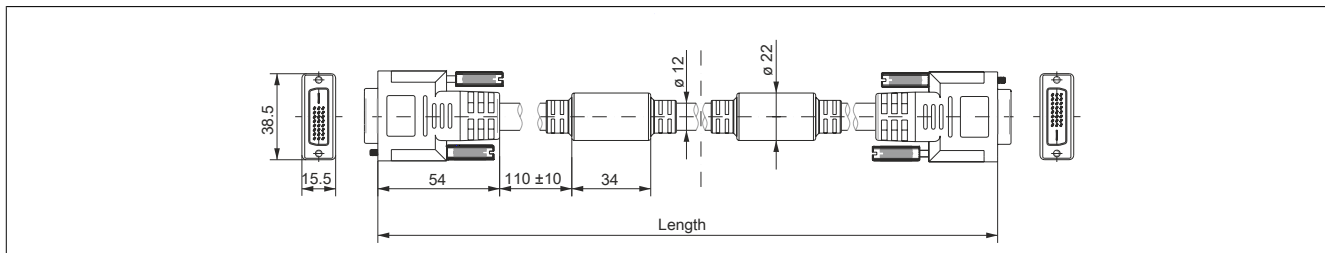

Figure 42: 5CASDL.0xxx-03 ≥Rev. E0 - Dimensions

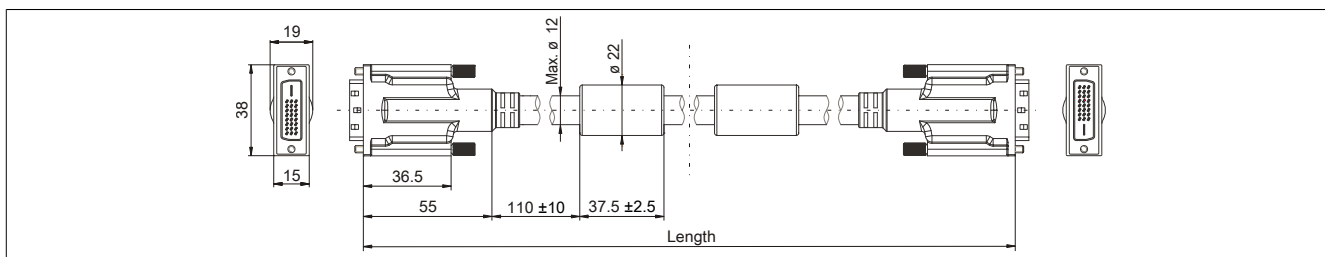

Figure 43: 5CASDL.0xxx-03 ≤Rev. D0 - Dimensions

6.3.4.1.6 Construction

Element	Assignment	Cross section	
DVI	TMDS data 0	26 AWG	
	TMDS data 1	26 AWG	
	TMDS data 2	26 AWG	
	TMDS cycle	26 AWG	
USB	XUSB0	26 AWG	
	XUSB1	26 AWG	
Data	SDL	26 AWG	
Control wires	DDC cycle	24 AWG	
	DDC data	24 AWG	
	+5 V	24 AWG	
	Ground	24 AWG	
	Hot plug detect	24 AWG	

Table 67: 5CASDL.0xxx-03 SDL flex cables - Construction

6.3.4.1.7 Cable pinout

Warning!

If a field-assembled cable is desired, it must be wired according to this pinout.

If a field-assembled cable is used, B&R cannot make any guarantee as to its functionality. Functionality is only ensured with cables provided by B&R.

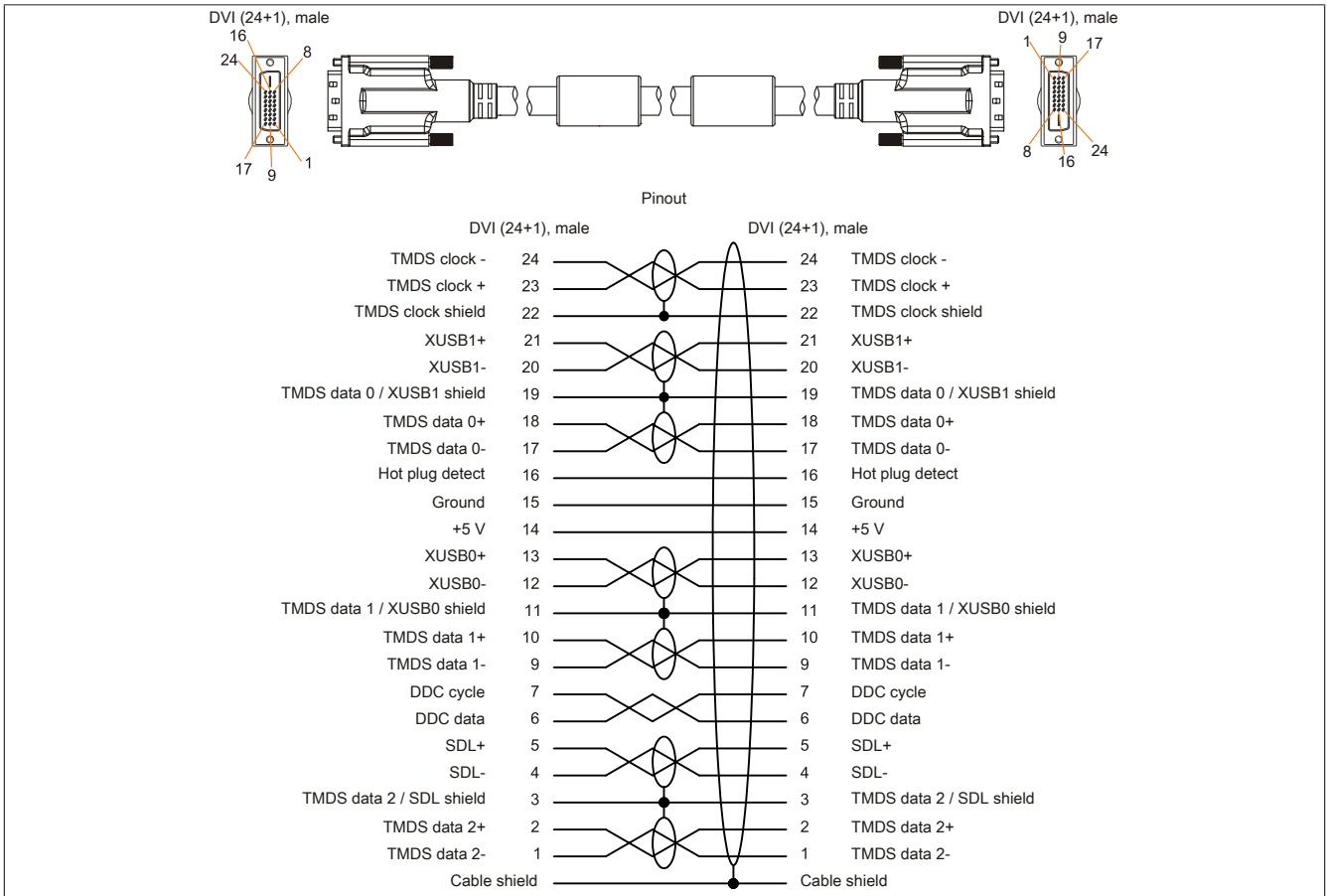

Figure 44: 5CASDL.0xxx-03 - Pinout

6.3.5 SDL flex cables with extender

6.3.5.1 5CASDL.0xx0-13

6.3.5.1.1 General information

5CASDL.0xx0-13 SDL flex cables with extender are designed for use in both fixed and flexible installations (e.g. swing arm systems).

Caution!

The cable is only permitted to be connected or disconnected when the power is switched off.

6.3.5.1.2 Order data

Model number	Short description	Figure
	SDL cables flex	
5CASDL.0300-13	SDL flex cable with extender - 30 m	
5CASDL.0400-13	SDL flex cable with extender - 40 m	
5CASDL.0430-13	SDL flex cable with extender - 43 m	

Table 68: 5CASDL.0300-13, 5CASDL.0400-13, 5CASDL.0430-13 - Order data

6.3.5.1.3 Technical data

Information:

The following specifications, properties and limit values apply only to this accessory and may deviate from those that apply to the complete system. For the complete system in which this accessory is installed, for example, the data specified for that complete system applies.

Model number	5CASDL.0300-13	5CASDL.0400-13	5CASDL.0430-13
General information			
Certifications			
CE		Yes	
UL		cULus E115267	
HazLoc		Industrial control equipment cULus HazLoc E180196	
DNV GL		Industrial control equipment for hazardous locations Class I, Division 2, Groups ABCD, T4 ¹⁾	
GOST-R		Temperature: B (0 - 55°C) Humidity: B (up to 100%) Vibration: A (0.7 g) EMC: B (Bridge and open deck) ²⁾	
		Yes	
Cable construction			
Wire cross section		24 AWG (control wires) 26 AWG (DVI, USB, data)	
Properties		Silicone- and halogen-free	
Shield		Individual cable pairs, entire cable	
Complete shielding		Aluminum-clad foil and tinned copper braiding	
Outer jacket			
Material		Special semi-matte TMPU	
Color		Black	
Labeling		(B&R) SDL cable (UL) AWM 20236 80°C 30 V E63216	
Connector			
Type		2x DVI-D (24+1), male	
Connection cycles		Min. 200	
Contacts		Gold-plated	
Mechanical protection		Metal cover with crimped strain relief	
Locating screw tightening torque		Max. 0.5 Nm	
Electrical characteristics			
Operating voltage		≤30 V	
Test voltage			
Wire/Wire		1 kV	
Wire/Shield		0.5 kV	
Wave impedance		100 ±10 Ω	
Conductor resistance			
24 AWG		≤95 Ω/km	
26 AWG		≤145 Ω/km	
Insulation resistance		>200 MΩ/km	

Table 69: 5CASDL.0300-13, 5CASDL.0400-13, 5CASDL.0430-13 - Technical data

Accessories

Model number	5CASDL.0300-13	5CASDL.0400-13	5CASDL.0430-13
Operating conditions			
Pollution degree per EN 61131		Pollution degree 2	
Approbation		UL AWM 20236 80°C 30 V	
Flame-retardant		Per UL 758 (cable vertical flame test)	
Oil and hydrolysis resistance		Per VDE 0282-10	
Environmental conditions			
Temperature			
Storage		-20 to 60°C	
Fixed installation		-20 to 60°C	
Flexible installation		-5 to 60°C	
Mechanical characteristics			
Dimensions			
Length	30 m ±280 mm	40 m ±380 mm	43 m ±410 mm
Diameter		Max. 12 mm	
Extender box			
Width		35 mm	
Length		125 mm	
Height		18.5 mm	
Bend radius			
Fixed installation		≥6x cable diameter (male connector - ferrite bead) ≥10x cable diameter (ferrite bead - ferrite bead)	
Flexible installation		≥15x cable diameter (ferrite bead - ferrite bead)	
Flexibility		Flexible, applies to ferrite bead - ferrite bead (tested 300000 cycles with 15x cable diameter, 4800 cycles/hour)	
Drag chain data			
Flex cycles		300,000	
Speed		4800 cycles/hour	
Bend radius		180 mm, 15x cable diameter	
Hub		460 mm	
Weight	Approx. 5430 g	Approx. 7200 g	Approx. 7790 g
Tension			
During operation		≤50 N	
During installation		≤400 N	

Table 69: 5CASDL.0300-13, 5CASDL.0400-13, 5CASDL.0430-13 - Technical data

- 1) Yes, although applies only if all components installed in the complete system have this certification and the complete system bears the corresponding mark.
- 2) Yes, although applies only if all components installed in the complete system have this certification and are listed on the associated DNV GL certificate for the product family.

6.3.5.1.4 Bend radius specifications

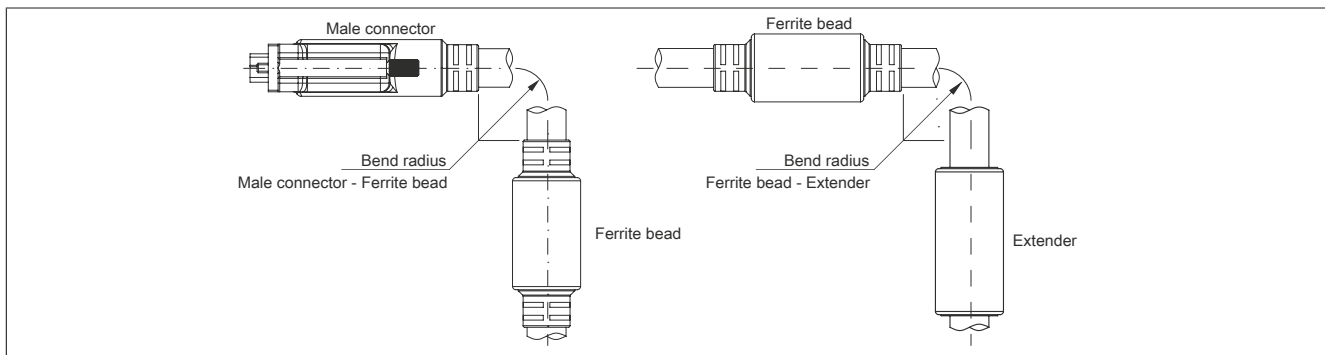

Figure 45: Bend radius specification with extender

6.3.5.1.5 Dimensions

All dimensions are specified in mm.

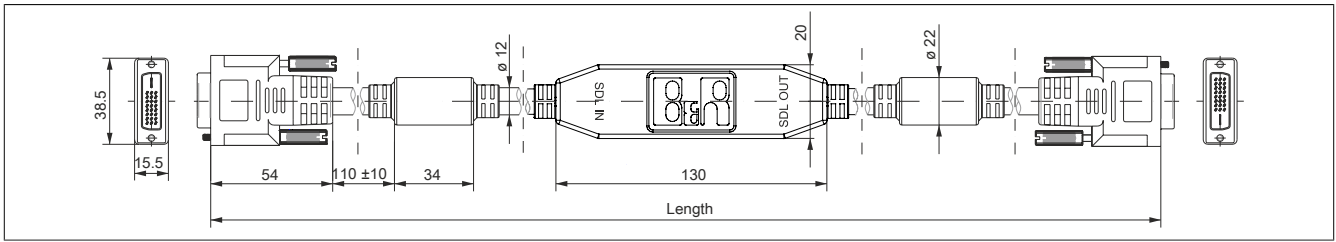

Figure 46: 5CASDL.xxx-13 ≥Rev. E0 - Dimensions

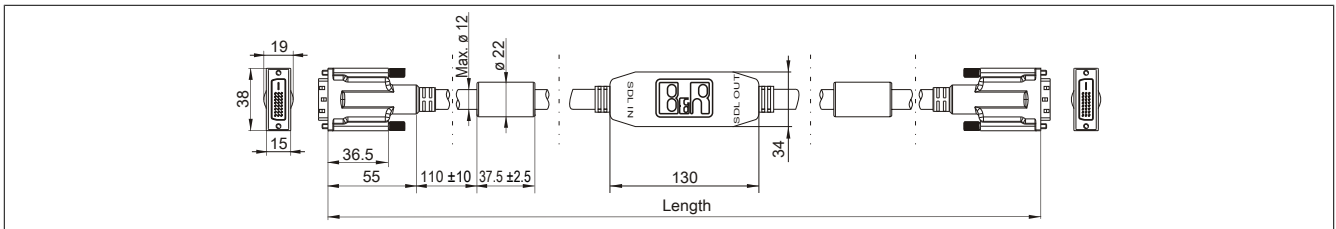

Figure 47: 5CASDL.0xx0-13 ≤Rev. D0 - Dimensions

6.3.5.1.6 Cable pinout

Warning!

If a field-assembled cable is desired, it must be wired according to this pinout.

If a field-assembled cable is used, B&R cannot make any guarantee as to its functionality. Functionality is only ensured with cables provided by B&R.

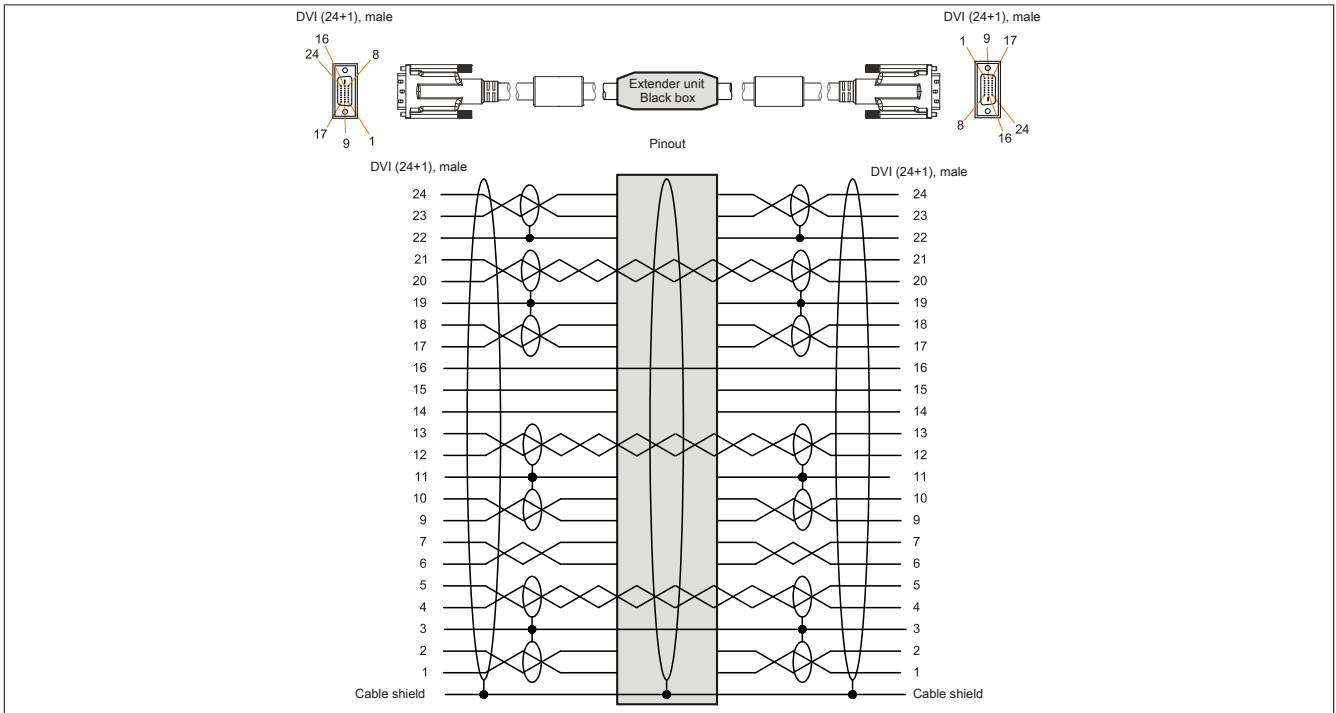

Figure 48: 5CASDL.0xx0-13 - Pinout

6.3.5.1.7 Cable connection

SDL flex cables with extender must be connected between the B&R industrial PC and Automation Panel in the correct direction. The correct signal direction is indicated on the extender.

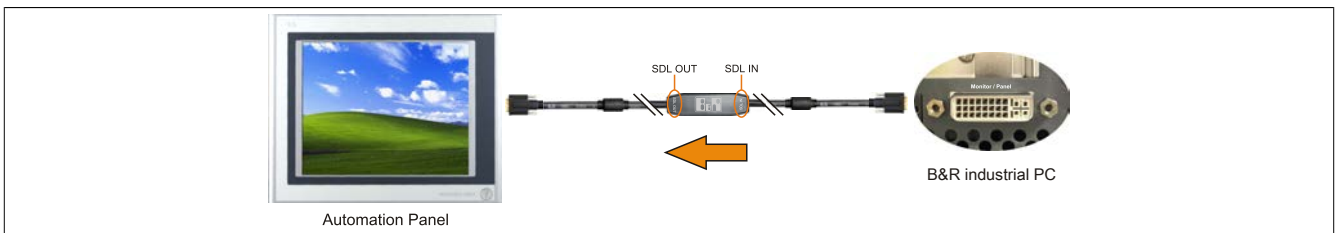

Figure 49: Signal direction for SDL flex cable with extender - Example

6.3.6 SDL3/SDL4 cables

6.3.6.1 5CASD3.xxxx-00

6.3.6.1.1 General information

5CASD3.xxxx-00 SDL3/SDL4 cables are designed to transfer SDL3/SDL4 data and simplify cable installation. The RJ45 connector allows these cables to be connected in very narrow spaces, for example in swing arm shafts.

Caution!

The cable is only permitted to be connected or disconnected when the power is switched off.

6.3.6.1.2 Order data

Model number	Short description	Figure
	SDL3/SDL4 cables	
5CASD3.0030-00	SDL3/SDL4 cable - 3 m	
5CASD3.0050-00	SDL3/SDL4 cable - 5 m	
5CASD3.0100-00	SDL3/SDL4 cable - 10 m	
5CASD3.0150-00	SDL3/SDL4 cable - 15 m	
5CASD3.0200-00	SDL3/SDL4 cable - 20 m	
5CASD3.0300-00	SDL3/SDL4 cable - 30 m	
5CASD3.0500-00	SDL3/SDL4 cable - 50 m	
5CASD3.1000-00	SDL3/SDL4 cable - 100 m	

Table 70: 5CASD3.0030-00, 5CASD3.0050-00, 5CASD3.0100-00, 5CASD3.0150-00, 5CASD3.0200-00, 5CASD3.0300-00, 5CASD3.0500-00, 5CASD3.1000-00 - Order data

6.3.6.1.3 Technical data

Information:

The following specifications, properties and limit values apply only to this accessory and may deviate from those that apply to the complete system. For the complete system in which this accessory is installed, for example, the data specified for that complete system applies.

Model number	5CASD3.0030-00	5CASD3.0050-00	5CASD3.0100-00	5CASD3.0150-00	5CASD3.0200-00	5CASD3.0300-00	5CASD3.0500-00	5CASD3.1000-00	
General information									
Certifications	Yes								
CE	Yes								
UL	cULus E115267 Industrial control equipment								
HazLoc	cULus HazLoc E180196 Industrial control equipment for hazardous locations Class I, Division 2, Groups ABCD, T4 ¹⁾			cULus HazLoc E180196 Industrial control equipment for haz- ardous locations Class I, Division 2, Groups ABCD, T4 ²⁾		cULus HazLoc E180196 Industrial control equipment for hazardous locations Class I, Division 2, Groups ABCD, T4 ¹⁾		cULus HazLoc E180196 Industrial control equipment for haz- ardous locations Class I, Division 2, Groups ABCD, T4 ²⁾	
Cable construction									
Wire cross section	4x 2x 26/7 AWG				4x 2x 23/1 AWG				
Properties	Flame-resistant, halogen-free, lead-free			Flame- retardant, halogen-free, lead-free		Flame-resistant, halo- gen-free, lead-free		Flame- retardant, halogen-free, lead-free	

Table 71: 5CASD3.0030-00, 5CASD3.0050-00, 5CASD3.0100-00, 5CASD3.0150-00, 5CASD3.0200-00, 5CASD3.0300-00, 5CASD3.0500-00, 5CASD3.1000-00 - Technical data

Accessories

Model number	5CASD3.0030-00	5CASD3.0050-00	5CASD3.0100-00	5CASD3.0150-00	5CASD3.0200-00	5CASD3.0300-00	5CASD3.0500-00	5CASD3.1000-00
Outer jacket								
Material	Polyurethane (PUR)							
Color	Yellow, RAL 1021							
Labeling	HARTING INDUSTRIAL CABLE S/ FTP CAT 6A PUR 4x 2x 26/7 AWG				HARTING INDUSTRIAL CABLE S/ FTP CAT 6A PUR 4x2x-AWG26/7		HARTING INDUSTRIAL INSTALLATION CABLE S/FTP CAT 7 PUR 4x 2x 23/1 AWG	HARTING INDUSTRIAL INSTALLATION CABLE S/ FTP CAT 7 PUR 4x2x-AWG23/1
Lines								
Wire insulation	Polyethylene (PE)							
Wire colors	Green/White-green, orange/white-orange, blue/white-blue, brown/white-brown							
Shield	Aluminum foil and braided wire shield made of tinned copper wires							
Type	Unprotected copper wire, 4x 2x 26/7 AWG				Unprotected copper wire, 4x 2x 23/1 AWG			
Connector								
Type	2x RJ45, male							
Connection cycles	Min. 750							
Contacts	8							
Electrical characteristics ³⁾								
Operating voltage	≤100 V				≤125 V			
Conductor resistance	≤290 Ω/km				≤75 Ω/km			
Wave impedance	100 ±5 Ω (at 100 MHz)							
Transfer properties	Category 6A / Class EA up to 500 MHz in accordance with ISO/IEC 11801 (EN 50173-1), ISO/IEC 24702 (EN 50173-3)				Category 6A / Class EA up to 500 MHz per ISO/IEC 11801 (EN 50173-1), ISO/IEC 24702 (EN 50173-3)		Category 7 / Class F up to 600 MHz in accordance with ISO/IEC 11801 (EN 50173-1), ISO/IEC 24702 (EN 50173-3)	Category 7 / Class F up to 600 MHz per ISO/IEC 11801 (EN 50173-1), ISO/IEC 24702 (EN 50173-3)
Insulation resistance	≥500 MΩ/km				≥5 GΩ/km			
Operating conditions								
Pollution degree per EN 61131-2	Pollution degree 2							
Flame-retardant	IEC 60332-1-2							
Oil and hydrolysis resistance	EN 60811-2-1 (90°C / 7x24 h)							
Degree of protection per EN 60529								
Cables	IP20							
RJ45 connector	IP20, only when connected properly				IP20, only when properly connected		IP20, only when connected properly	IP20, only when properly connected
Environmental conditions								
Temperature								
Storage	-40 to 70°C							
Fixed installation	-40 to 70°C							
Flexible installation	-40 to 70°C				-10 to 50°C			
Mechanical characteristics								
Dimensions								
Length	3 m	5 m	10 m	15 m	20 m	30 m	50 m	100 m
Diameter	6.7 mm				8.3 mm			
Bend radius								
Fixed installation	≥5x diameter				≥4x diameter			
Flexible installation	≥10x diameter				≥8x diameter			
Weight	250 g	500 g	700 g	950 g	2150 g	3500 g	6950 g	
Tension								
During operation	≤70 N				≤110 N			
During installation	≤70 N				≤110 N			

Table 71: 5CASD3.0030-00, 5CASD3.0050-00, 5CASD3.0100-00, 5CASD3.0150-00, 5CASD3.0200-00, 5CASD3.0300-00, 5CASD3.0500-00, 5CASD3.1000-00 - Technical data

- 1) Yes, although applies only if all components installed within the complete system have this certification and the complete system itself carries the corresponding mark.
- 2) Yes, although applies only if all components installed in the complete system have this certification and the complete system bears the corresponding mark.
- 3) At an ambient temperature of 20°C.

6.3.6.1.4 Bend radius specifications

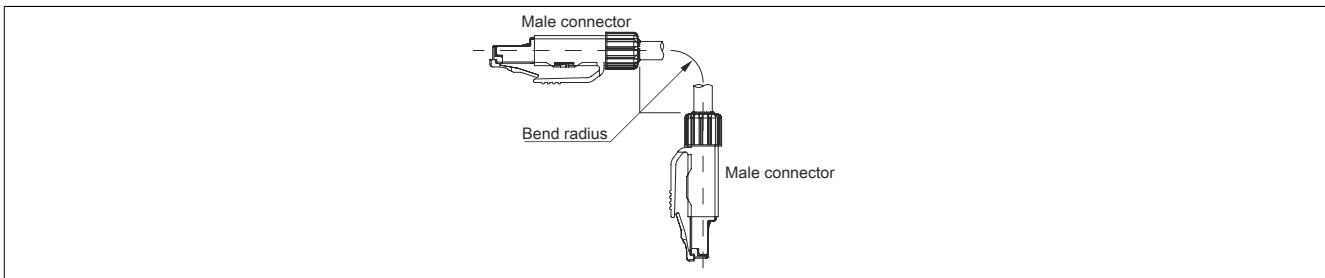

Figure 50: SDL3/SDL4 bending radius specification

6.3.6.1.5 Dimensions

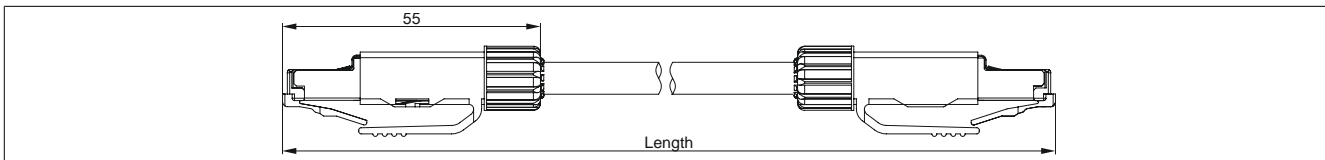

Figure 51: 5CASD3.xxxx-00 - Dimensions

6.3.6.1.6 Cable pinout

Warning!

If a field-assembled cable is desired, it must be wired according to this pinout.

If a field-assembled cable is used, B&R cannot make any guarantee as to its functionality. Functionality is only ensured with cables provided by B&R.

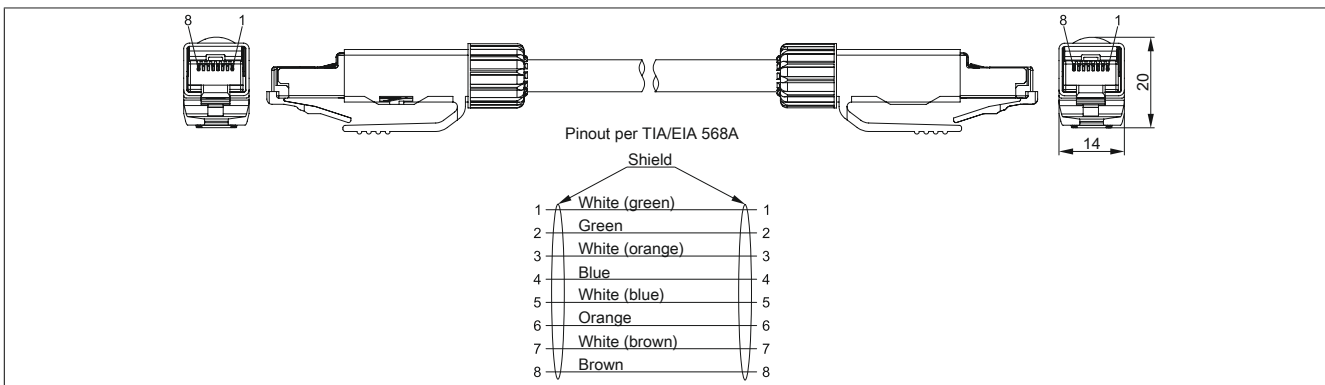

Figure 52: 5CASD3.xxxx-00 - Pinout

6.3.6.1.7 Wiring

The following information and figure apply when using a field-assembled cable that is not directly connected to a B&R device, but to an RJ45 network interface (e.g. patch panel).

Wiring must meet category 6a (Cat 6a) or category 7 (Cat 7) requirements. Exceeding the maximum total length of 100 m is not permitted.

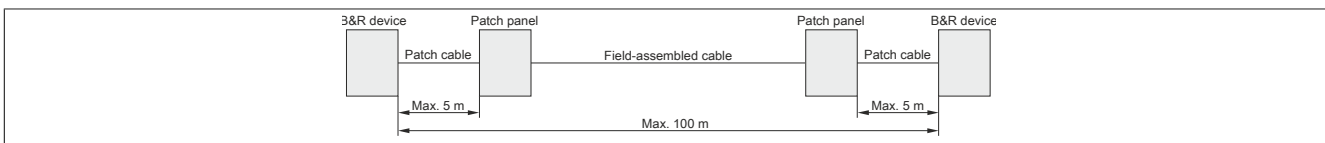

Figure 53: Wiring with a field-assembled cable

6.3.7 USB cables

6.3.7.1 5CAUSB.00xx-00

6.3.7.1.1 General information

USB cables are designed for a USB 2.0 transfer rate.

6.3.7.1.2 Order data

Model number	Short description	Figure
	USB cables	
5CAUSB.0018-00	USB 2.0 connection cable - Type A - type B connector - 1.8 m	
5CAUSB.0050-00	USB 2.0 connection cable - Type A - type B connector - 5 m	

Table 72: 5CAUSB.0018-00, 5CAUSB.0050-00 - Order data

6.3.7.1.3 Technical data

Information:

The following specifications, properties and limit values apply only to this accessory and may deviate from those that apply to the complete system. For the complete system in which this accessory is installed, for example, the data specified for that complete system applies.

Model number	5CAUSB.0018-00	5CAUSB.0050-00
General information		
Certifications		
CE	Yes	
UL	cULus E115267 Industrial control equipment	
DNV GL	Temperature: B (0 - 55°C) Humidity: B (up to 100%) Vibration: A (0.7 g) EMC: B (Bridge and open deck) ¹⁾	
GOST-R	Yes	
Cable construction		
Wire cross section	24, 28 AWG	
Shield	Entire cable	
Outer jacket		
Color	Beige	
Connector		
Type	USB type A male and USB type B male	
Operating conditions		
Pollution degree per EN 61131	Pollution degree 2	
Mechanical characteristics		
Dimensions		
Length	1.8 m ±30 mm	5 m ±50 mm
Diameter	Max. 5 mm	
Bend radius	Min. 100 mm	

Table 73: 5CAUSB.0018-00, 5CAUSB.0050-00 - Technical data

1) Yes, although applies only if all components installed in the complete system have this certification and are listed on the associated DNV GL certificate for the product family.

6.3.7.1.4 Cable pinout

Warning!

If a field-assembled cable is desired, it must be wired according to this pinout.

If a field-assembled cable is used, B&R cannot make any guarantee as to its functionality. Functionality is only ensured with cables provided by B&R.

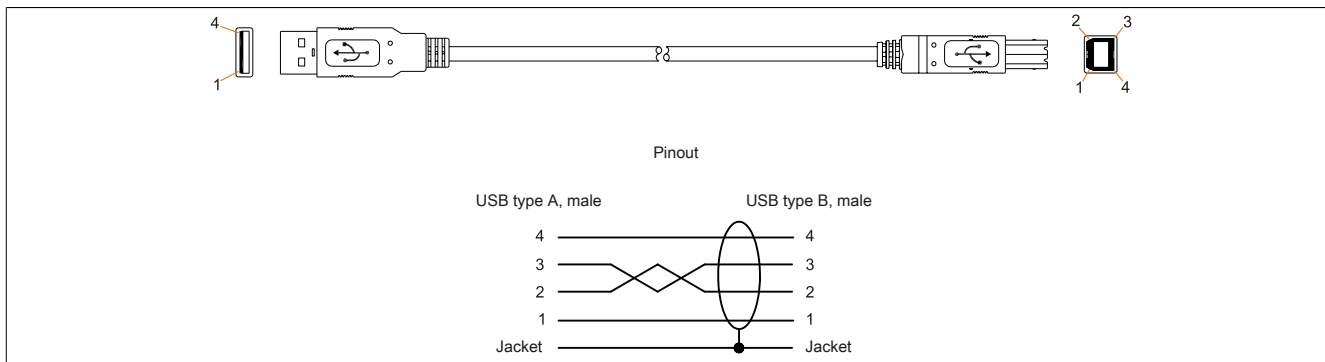

Figure 54: 5CAUSB.00xx-00 USB cables - Pinout

6.3.8 RS232 cables

6.3.8.1 9A0014.xx

6.3.8.1.1 General information

RS232 cables are used as extension cables between two RS232 interfaces.

6.3.8.1.2 Order data

Model number	Short description	Figure
	RS232 cables	
9A0014.02	RS232 extension cable for operation of a remote display unit with touch screen, 1.8 m	
9A0014.05	RS232 extension cable for operation of a remote display unit with touch screen, 5 m	
9A0014.10	RS232 extension cable for operation of a remote display unit with touch screen, 10 m	

Table 74: 9A0014.02, 9A0014.05, 9A0014.10 - Order data

6.3.8.1.3 Technical data

Information:

The following specifications, properties and limit values apply only to this accessory and may deviate from those that apply to the complete system. For the complete system in which this accessory is installed, for example, the data specified for that complete system applies.

Model number	9A0014.02	9A0014.05	9A0014.10
General information			
Certification		Yes	
CE		Yes	
GOST-R	-		Yes
Cable construction			
Wire cross section		26 AWG	
Shield		Entire cable	
Outer sheathing			
Color		Beige	
Connector			
Type		9-pin DSUB connector, male/female	
Locating screw tightening torque		Max. 0.5 Nm	
Operating conditions			
EN 61131 pollution degree		Pollution degree 2	
Mechanical characteristics			
Dimensions			
Length	1.8 m ±50 mm	5 m ±80 mm	10 m ±100 mm
Diameter		Max. 5 mm	
Bend radius		Min. 70 mm	

Table 75: 9A0014.02, 9A0014.05, 9A0014.10 - Technical data

6.3.8.1.4 Cable pinout

Warning!

If a field-assembled cable is desired, it must be wired according to this pinout.

If a field-assembled cable is used, B&R cannot make any guarantee as to its functionality. Functionality is only ensured with cables provided by B&R.

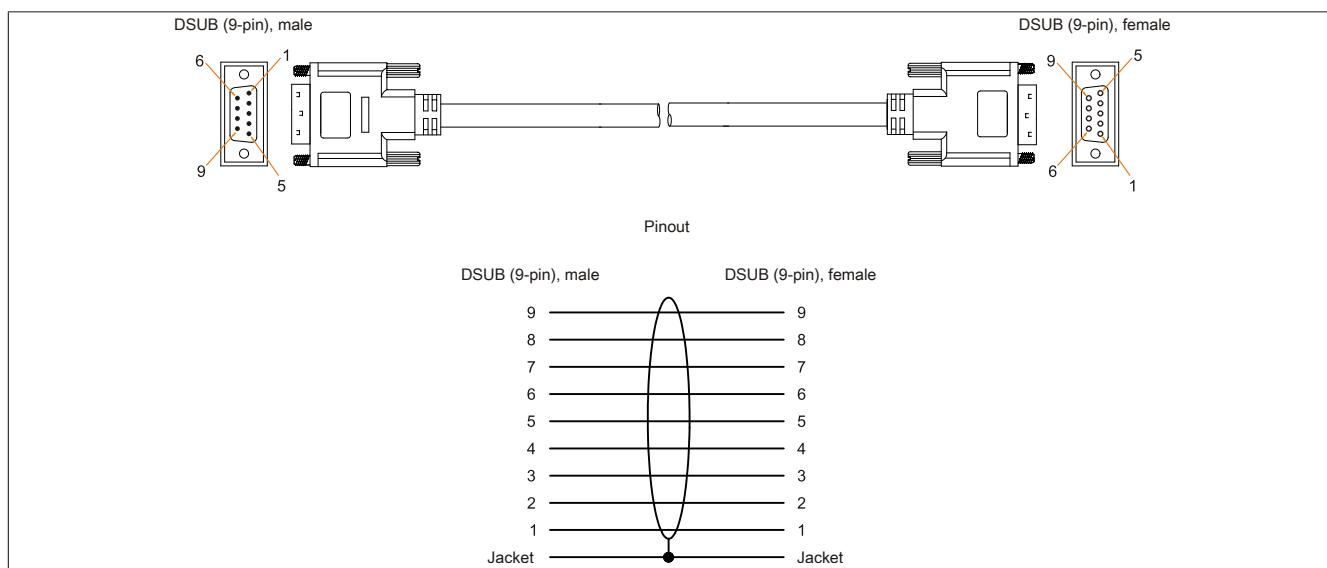

Figure 55: 9A0014.xx RS232 cables - Pinout

7 Servicing and maintenance

This chapter describes the servicing/maintenance work that is possible to be carried out by a trained and qualified end user.

Information:

Only components approved by B&R are permitted to be used for maintenance and repair work.

7.1 Cleaning

Danger!

The device is only permitted to be cleaned when power is switched off in order to prevent unintended functions from being triggered by touching the touch screen or pressing keys.

Use a moist cloth to clean the device. Only use water with detergent, a screen cleaning agent or alcohol (ethanol) to moisten the cleaning cloth. Apply the cleaning agent to the cloth beforehand; do not spray it directly on the device! Never use aggressive solvents, chemicals, scouring agents, pressurized air or steam-jet air ejectors.

Information:

Displays with a touch screen should be cleaned at regular intervals.

7.2 Tips for extending the service life of the display

7.2.1 Backlight

The service life of the backlight is specified by its "half-brightness time". An operating time of 50,000 would mean that the display would still retain 50% of its brightness after this time.

7.2.1.1 How can the service life of backlights be extended?

- Setting the display brightness to the lowest value that is still comfortable for the eyes
- Using dark images
- Reducing the brightness by 50% can increase the half-brightness time by approximately 50%.

7.2.2 Image persistence

Image persistence refers to the "burning in" of a static image on a display after being displayed for a prolonged period of time. This not only occurs with static images, however. Image persistence is also referred to in the technical literature as burn-in effect, image retention, memory effect, memory sticking or ghost image.

There are basically 2 types:

- Area type: This type is characterized by a dark gray image. The effect disappears if the display is switched off for a long period of time.
- Line type: Can result in permanent damage.

7.2.2.1 What causes image persistence?

- Static images
- No screensaver
- Sharp transitions in contrast (e.g. black/white)
- High ambient temperatures
- Operation outside of specifications

7.2.2.2 How can image persistence be reduced?

- Constantly switching between static and dynamic images
- Avoiding excessive brightness differences between foreground and background elements
- Using colors with similar brightness
- Using complementary colors in consecutive images
- Using screensavers

7.3 Pixel errors

Information:

Displays may contain defective pixels (pixel errors) that result from the manufacturing process. They are not grounds for initiating a complaint or warranty claim.

Appendix A

A.1 Abbreviations

Abbreviation	Stands for	Description
NC	Normally closed	Normally closed relay contact.
	Not connected	Used in pinout descriptions if a terminal or pin is not connected on the module side.
ND	Not defined	In technical data tables, this stands for a value that is not defined. This may be because a cable manufacturer does not provide a value for certain technical data, for example.
NO	Normally open	Normally open relay contact.
TBD	To be defined	Used in technical data tables when there is currently no value for specific technical data. The value will be provided at a later point in time.
B_{100}	-	Number of cycles before 10% of the components have experienced hazardous failure (per channel).
$MTTF_D$	Mean Time to Dangerous Failure	Average time before hazardous failure occurs (per channel).
DC	Diagnostic coverage	Diagnostic coverage
PL	Performance level	Discrete level that specifies the ability of safety-related devices to perform a safety function under foreseeable conditions.
PFH	Probability of Failure per Hour	Probability of failure per hour.
SIL	Safety integrity level	Safety integrity level

Table 76: Abbreviations used in this user's manual

A.2 Viewing angles

For the viewing angle values of display types (R, L, U, D), see the technical data of the individual components.

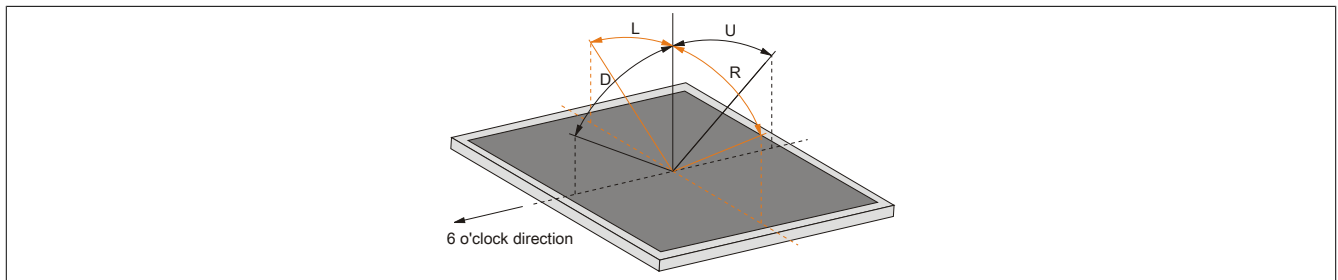

A.3 Chemical resistance

Panels are manufactured with the Autotex panel overlay:

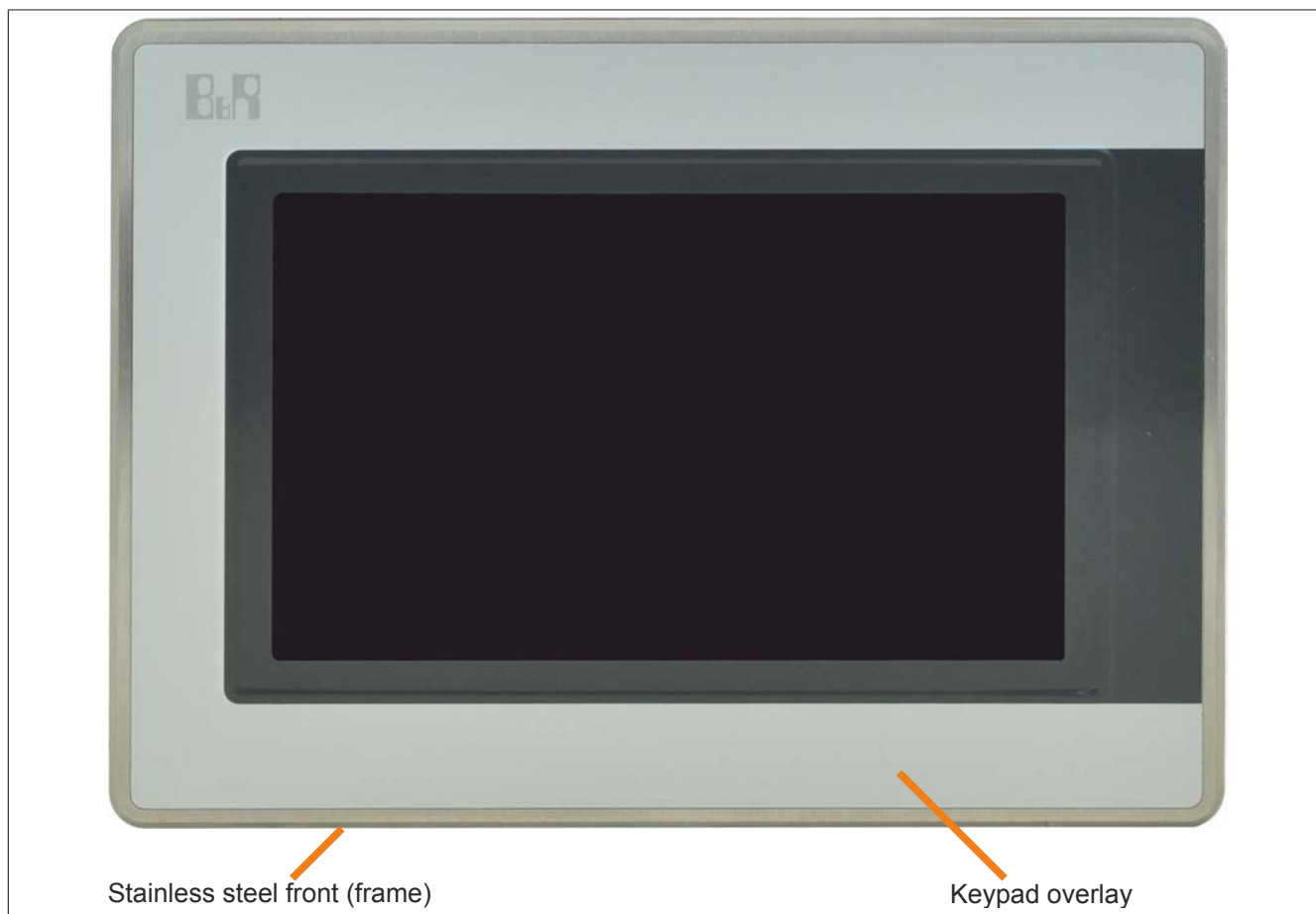

A.3.1 Autotex panel overlay (polyester)

Unless otherwise specified, the panel overlay is resistant to exposure to the following chemicals for up to 24 hours with no visible signs of damage per DIN 42115 Part 2:

- Acetaldehyde
- Acetone
- Acetonitrile
- Aliphatic hydrocarbons
- Alkali carbonate
- Formic acid <50%
- Ammonia <40%
- Amyl acetate
- Ethanol
- Ether
- Gasoline
- Bichromate
- Potassium
- Cutting oil
- Brake fluid
- Butylcellosolve
- Sodium hypochlorite <20%
- Cyclohexanol
- Cyclohexanone
- Decon
- Diacetone alcohol
- Dibutyl phthalate
- Diesel
- Diethyl ether
- Diethyl phthalate
- Dioxan
- Dowandol
- DRM/PM
- Iron chloride (FeCl₂)
- Iron chloride (FeCl₃)
- Acetic acid <50%
- Ethyl acetate
- Linseed oil
- Aviation fuel
- Formaldehyde 37 to 42%
- Glycerine
- Glycol
- Isophorone
- Isopropanol
- Potassium hydroxide
- Potassium carbonate
- Methanol
- Methylisobutylketone
- MIBK
- Sodium bisulphate
- Sodium carbonate
- Caustic soda <40%
- N-Butyl acetate
- Paraffin oil
- Phosphoric acid <30%
- Blown castor oil
- Nitric acid <10%
- Hydrochloric acid <36%
- Sea water
- Sulphuric acid <10%
- Silicon oil
- Tenside
- Turpentine oil replacement
- Toluene
- Triacetin
- Trichloroacetic acid <50%
- Trichloroethane
- White spirits
- Washing agents
- Water
- Hydrogen peroxide <25%
- Fabric conditioner
- Xylene

The panel overlay is resistant to exposure to glacial acetic acid for less than one hour without visible damage per DIN 42115 Part 2.

Figure 1:	Automation Panel 1000 - Spacing for air circulation.....	22
Figure 2:	Automation Panel 1000 - Mounting orientation.....	23
Figure 3:	Automation Panel 1000 - Temperature sensor position.....	28
Figure 4:	SDL/DVI receiver link module - Block diagram.....	31
Figure 5:	SDL3 receiver link module - Block diagram.....	31
Figure 6:	SDL4 receiver link module - Block diagram.....	31
Figure 7:	Overview of interfaces - SDL/DVI receiver link module.....	32
Figure 8:	Ground connection.....	33
Figure 9:	Brightness controls.....	37
Figure 10:	Overview of interfaces - SDL3 receiver link module.....	38
Figure 11:	Ground connection.....	39
Figure 12:	Overview of interfaces - SDL4 receiver link module.....	42
Figure 13:	Ground connection.....	43
Figure 14:	5AP1120.0702-I00 - Dimensions.....	48
Figure 15:	5AP1125.1043-I00 - Dimensions.....	50
Figure 16:	5AP1125.1044-I00 - Dimensions.....	52
Figure 17:	5AP1125.1505-I00 - Dimensions.....	54
Figure 18:	Removing the Torx screws.....	64
Figure 19:	Removing the link module.....	64
Figure 20:	Installing a screw clamp terminal block.....	65
Figure 21:	Installing a cage clamp terminal block.....	65
Figure 22:	Connecting the power supply connector to a B&R device.....	66
Figure 23:	Automation Panel 1000 - Grounding concept.....	67
Figure 24:	Bend radius - Cable connection.....	68
Figure 25:	Adjusting the display brightness.....	71
Figure 26:	Brightness controls.....	71
Figure 27:	ADI Control Center screenshots - Examples.....	72
Figure 28:	ADI Development Kit Screenshots (Symbolbild).....	74
Figure 29:	ADI .NET SDK screenshots.....	75
Figure 30:	5MMUSB.xxxx-01 - Temperature/Humidity diagram.....	81
Figure 31:	5MMUSB.032G-02 - Temperature/Humidity diagram.....	83
Figure 32:	Bend radius specifications.....	85
Figure 33:	5CADVI.0xxx-00 - Dimensions.....	85
Figure 34:	5CADVI.0xxx-00 - Pinout.....	86
Figure 35:	Bend radius specifications.....	88
Figure 36:	5CASDL.0xxx-00 - Dimensions.....	88
Figure 37:	5CASDL.0xxx-00 - Pinout.....	89
Figure 38:	Bend radius specifications.....	91
Figure 39:	5CASDL.0xxx-01 - Dimensions.....	91
Figure 40:	5CASDL.0xxx-01 - Pinout.....	92
Figure 41:	Bend radius specifications.....	94
Figure 42:	5CASDL.0xxx-03 ≥Rev. E0 - Dimensions.....	95
Figure 43:	5CASDL.0xxx-03 ≤Rev. D0 - Dimensions.....	95
Figure 44:	5CASDL.0xxx-03 - Pinout.....	96
Figure 45:	Bend radius specification with extender.....	98
Figure 46:	5CASDL.xxxx-13 ≥Rev. E0 - Dimensions.....	99
Figure 47:	5CASDL.0xx0-13 ≤Rev. D0 - Dimensions.....	99
Figure 48:	5CASDL.0xx0-13 - Pinout.....	100
Figure 49:	Signal direction for SDL flex cable with extender - Example.....	100
Figure 50:	SDL3/SDL4 bending radius specification.....	103
Figure 51:	5CASD3.xxxx-00 - Dimensions.....	103
Figure 52:	5CASD3.xxxx-00 - Pinout.....	103
Figure 53:	Wiring with a field-assembled cable.....	103
Figure 54:	5CAUSB.00xx-00 USB cables - Pinout.....	105
Figure 55:	9A0014.xx RS232 cables - Pinout	107

Table 1:	Environmentally friendly disposal.....	11
Table 2:	Organization of safety notices.....	12
Table 3:	Organization of general notices.....	12
Table 4:	Range of nominal sizes.....	12
Table 5:	AP1000 panels with retaining clips - Installation diagrams.....	21
Table 6:	Automation Panel 1000 with SDL/DVI receiver - Mounting orientations.....	23
Table 7:	Automation Panel 1000 with SDL3 receiver - Mounting orientations.....	23
Table 8:	Automation Panel 1000 with SDL4 receiver - Mounting orientations.....	24
Table 9:	AP1000 panels - Weight.....	24
Table 10:	Link modules - Weight.....	24
Table 11:	Maximum ambient temperature during operation.....	25
Table 12:	Minimum ambient temperature during operation.....	26
Table 13:	AP9x3 panels - Ambient temperature during storage and transport.....	26
Table 14:	Link modules - Ambient temperature during storage and transport.....	26
Table 15:	Temperature sensor position.....	28
Table 16:	AP1000 panels - Relative humidity.....	29
Table 17:	Link modules - Humidity.....	29
Table 18:	Vibration.....	29
Table 19:	Shock.....	29
Table 20:	+24 VDC voltage supply connection.....	30
Table 21:	Link modules - Power calculation.....	30
Table 22:	AP1000 panels - Power calculation.....	30
Table 23:	+24 VDC voltage supply connection.....	33
Table 24:	Panel In interface - SDL, DVI.....	34
Table 25:	DVI interface - Pinout.....	34
Table 26:	Cable lengths and resolutions for SDL transmission.....	35
Table 27:	Cable lengths and resolutions for DVI transfer.....	35
Table 28:	USB1/USB2 interface.....	36
Table 29:	USB In interface.....	37
Table 30:	COM - Pinout.....	37
Table 31:	+24 VDC voltage supply connection.....	39
Table 32:	SDL3 In interface.....	40
Table 33:	SDL3 In LEDs.....	40
Table 34:	USB1/USB2 interface.....	41
Table 35:	+24 VDC voltage supply connection.....	43
Table 36:	SDL4 In interface.....	44
Table 37:	SDL4 In LEDs.....	44
Table 38:	USB1/USB2 interface.....	45
Table 39:	5AP1120.0702-I00 - Order data.....	47
Table 40:	5AP1120.0702-I00 - Technical data.....	47
Table 41:	5AP1125.1043-I00 - Order data.....	49
Table 42:	5AP1125.1043-I00 - Technical data.....	49
Table 43:	5AP1125.1044-I00 - Order data.....	51
Table 44:	5AP1125.1044-I00 - Technical data.....	51
Table 45:	5AP1125.1505-I00 - Order data.....	53
Table 46:	5AP1125.1505-I00 - Technical data.....	53
Table 47:	5DLSDL.1001-00 - Order data.....	55
Table 48:	5DLSDL.1001-00 - Technical data.....	55
Table 49:	5DLSD3.1001-00 - Order data.....	57
Table 50:	5DLSD3.1001-00 - Technical data.....	57
Table 51:	5DLSD4.1001-00 - Order data.....	59
Table 52:	5DLSD4.1001-00 - Technical data.....	59
Table 53:	0TB103.9, 0TB103.91 - Order data.....	78
Table 54:	0TB103.9, 0TB103.91 - Technical data.....	78
Table 55:	5MMUSB.2048-01, 5MMUSB.4096-01 - Order data.....	80
Table 56:	5MMUSB.2048-01, 5MMUSB.4096-01 - Technical data.....	80
Table 57:	5MMUSB.032G-02 - Order data.....	82

Table 58:	5MMUSB.032G-02 - Technical data.....	82
Table 59:	5CADVI.0018-00, 5CADVI.0050-00, 5CADVI.0100-00 - Order data.....	84
Table 60:	5CADVI.0018-00, 5CADVI.0050-00, 5CADVI.0100-00 - Technical data.....	84
Table 61:	5CASDL.0008-00, 5CASDL.0018-00, 5CASDL.0050-00, 5CASDL.0100-00, 5CASDL.0150-00, 5CASDL.0200-00, 5CASDL.0250-00, 5CASDL.0300-00 - Order data.....	87
Table 62:	5CASDL.0008-00, 5CASDL.0018-00, 5CASDL.0050-00, 5CASDL.0100-00, 5CASDL.0150-00, 5CASDL.0200-00, 5CASDL.0250-00, 5CASDL.0300-00 - Technical data.....	87
Table 63:	5CASDL.0018-01, 5CASDL.0050-01, 5CASDL.0100-01, 5CASDL.0150-01 - Order data.....	90
Table 64:	5CASDL.0018-01, 5CASDL.0050-01, 5CASDL.0100-01, 5CASDL.0150-01 - Technical data....	90
Table 65:	5CASDL.0018-03, 5CASDL.0050-03, 5CASDL.0100-03, 5CASDL.0150-03, 5CASDL.0200-03, 5CASDL.0250-03, 5CASDL.0300-03 - Order data.....	93
Table 66:	5CASDL.0018-03, 5CASDL.0050-03, 5CASDL.0100-03, 5CASDL.0150-03, 5CASDL.0200-03, 5CASDL.0250-03, 5CASDL.0300-03 - Technical data.....	93
Table 67:	5CASDL.0xxx-03 SDL flex cables - Construction.....	95
Table 68:	5CASDL.0300-13, 5CASDL.0400-13, 5CASDL.0430-13 - Order data.....	97
Table 69:	5CASDL.0300-13, 5CASDL.0400-13, 5CASDL.0430-13 - Technical data.....	97
Table 70:	5CASD3.0030-00, 5CASD3.0050-00, 5CASD3.0100-00, 5CASD3.0150-00, 5CASD3.0200-00, 5CASD3.0300-00, 5CASD3.0500-00, 5CASD3.1000-00 - Order data.....	101
Table 71:	5CASD3.0030-00, 5CASD3.0050-00, 5CASD3.0100-00, 5CASD3.0150-00, 5CASD3.0200-00, 5CASD3.0300-00, 5CASD3.0500-00, 5CASD3.1000-00 - Technical data.....	101
Table 72:	5CAUSB.0018-00, 5CAUSB.0050-00 - Order data.....	104
Table 73:	5CAUSB.0018-00, 5CAUSB.0050-00 - Technical data.....	104
Table 74:	9A0014.02, 9A0014.05, 9A0014.10 - Order data.....	106
Table 75:	9A0014.02, 9A0014.05, 9A0014.10 - Technical data.....	106
Table 76:	Abbreviations used in this user's manual.....	110

0TB103.9.....	78
0TB103.91.....	78
5AP1120.0702-I00.....	47
5AP1125.1043-I00.....	49
5AP1125.1044-I00.....	51
5AP1125.1505-I00.....	53
5CADVI.0018-00.....	84
5CADVI.0050-00.....	84
5CADVI.0100-00.....	84
5CASD3.0030-00.....	101
5CASD3.0050-00.....	101
5CASD3.0100-00.....	101
5CASD3.0150-00.....	101
5CASD3.0200-00.....	101
5CASD3.0300-00.....	101
5CASD3.0500-00.....	101
5CASD3.1000-00.....	101
5CASDL.0008-00.....	87
5CASDL.0018-00.....	87
5CASDL.0018-01.....	90
5CASDL.0018-03.....	93
5CASDL.0050-00.....	87
5CASDL.0050-01.....	90
5CASDL.0050-03.....	93
5CASDL.0100-00.....	87
5CASDL.0100-01.....	90
5CASDL.0100-03.....	93
5CASDL.0150-00.....	87
5CASDL.0150-01.....	90
5CASDL.0150-03.....	93
5CASDL.0200-00.....	87
5CASDL.0200-03.....	93
5CASDL.0250-00.....	87
5CASDL.0250-03.....	93
5CASDL.0300-00.....	87
5CASDL.0300-03.....	93
5CASDL.0300-13.....	97
5CASDL.0400-13.....	97
5CASDL.0430-13.....	97
5CAUSB.0018-00.....	104
5CAUSB.0050-00.....	104
5DLSD3.1001-00.....	57
5DLSD4.1001-00.....	59
5DLSDL.1001-00.....	55
5MMUSB.032G-02.....	82
5MMUSB.2048-01.....	80
5MMUSB.4096-01.....	80
9A0014.02.....	106
9A0014.05.....	106
9A0014.10.....	106

A

Accessories.....	78
ADI.....	72
.NET SDK.....	75
Development Kit.....	74
Adjusting the display brightness.....	71
Administrator accounts.....	11
Ambient temperature.....	25
Ambient temperature during storage and transport.....	26

B

B&R Automation Device Interface.....	72
B&R Control Center.....	72
Backlight.....	37
Bend radius.....	68
Bend radius specifications.....	68
Block diagrams.....	31
Brightness.....	37
Brightness controls.....	37

C

Cable connections.....	68
Cable lengths.....	35, 35
Cables.....	84
DVI.....	84
RS232.....	106
SDL.....	87
SDL3.....	101
SDL flex.....	93
SDL flex cables with extender.....	97
SDL with 45° male connector.....	90
USB.....	104
CE marking.....	76
Certifications.....	77
Chemical resistance.....	111
Cleaning.....	108
COM.....	37
Complete system.....	16
Conduct interference.....	67
Configuration.....	16
Control Center.....	72
Creating reports.....	73

D

DC power cable.....	65
Defective pixels.....	109
Dimension standards.....	12
Display brightness.....	71
Disposal.....	11, 11
DVI cables.....	84
DVI mode	
With multi-touch Automation Panel.....	18
DVI operation.....	18
With single-touch Automation Panel.....	18
DVI transfer.....	35, 35

E

Electrical characteristics.....	30
Block diagrams.....	31
Power calculation.....	30
Electromagnetic compatibility.....	76
EMC directive.....	76
Environmental characteristics.....	25
Ambient temperature during storage and transport.....	26
Humidity.....	29
Maximum ambient temperature.....	25
Minimum ambient temperature during operation.....	26
Protection.....	29
Shock.....	29
Temperature.....	25
Temperature sensors.....	28
Vibration.....	29
ESD.....	9
Electrical components with a housing.....	9
Electrical components without a housing.....	9
Individual components.....	9
Packaging.....	9

F

Functional ground.....	67
------------------------	----

G

General tolerance.....	12
Ground connection.....	33, 39, 43
Grounding.....	33, 39, 43, 67
Guidelines.....	12

H

Humidity.....	29
---------------	----

I

Image persistence.....	109
Immunity to interference.....	67
Installation	
Link module.....	64
Installation diagrams.....	21, 21
Installing the DC power cable.....	65
Interfaces	
+24 VDC power supply.....	30, 33, 39, 43
Grounding.....	33, 39, 43
Panel In.....	34
SDL3 In.....	40
SDL4 In.....	44
USB.....	36, 41, 45
USB In interface.....	37

L

LEDs.....	40, 44
Link module.....	15
Link module or system unit.....	16
Link modules.....	55

Low voltage directive.....	76
M	
Mechanical characteristics	
Installation diagrams.....	21
Mounting orientations.....	23
Spacing for air circulation.....	21
Weight specifications.....	24
Mechanical properties.....	21
Mounting an Automation Panel 1000 with retaining clips.....	61
P	
Panel.....	16
Panel In interface.....	34
Panel overlay.....	111
Panels.....	47
Pixel errors.....	109
Power calculation.....	30, 30
Power connectors.....	78
Power grid connection	
DC power cable.....	65
Power rating.....	30
Power supply.....	30, 33, 39, 43
Pressure frame.....	16
Proper ESD handling.....	9
Protection.....	29
Publishing information.....	2
R	
Relative humidity.....	29
Replacing link modules.....	64
Resolution for DVI transfer.....	35
RS232 cables.....	106
S	
Safety guidelines.....	9, 11
Environmental conditions.....	10
Environmentally friendly disposal.....	11
Installation.....	10
Intended use.....	9
Operation.....	10
Policies and procedures.....	9
Protection against electrostatic discharge.....	9
Separation of materials.....	11
Transport and storage.....	10
Screen burn-in.....	109
SDL3/SDL4 cables.....	101
SDL3 In interface.....	40
SDL3 In LEDs.....	40
SDL3 mode.....	19
With SDL3 transmitter.....	19
SDL3 resolution.....	40
SDL4 In interface.....	44
SDL4 In LEDs.....	44
SDL cables.....	87
SDL cables with 45° male connector.....	90
SDL flex cables.....	93

SDL flex cables with extender.....	97
SDL operation.....	17
Mode 1.....	17
Mode 2.....	17
SDL resolution.....	35
SDL transmission.....	35, 35
Security concept.....	11
Serial interface.....	37
Service life of the display.....	109
Shock.....	29, 29
Single-touch.....	70
Software versions.....	73
Space for air circulation.....	21
Spacing specifications for air circulation.....	22
Standards and guidelines.....	76
Switching on the device for the first time.....	69

T

Temperature monitoring.....	27
Temperature sensor positions.....	28
Temperature specifications.....	4, 4
Terminal block.....	16
Third-party software updates.....	11
Total power.....	30
Touch screen calibration.....	70

U

Universal Serial Bus 2.0.....	45
Upgrade	
Firmware.....	72
Upgrade information.....	72
Upgrading the firmware.....	72
USB 2.0.....	36, 41
USB cables.....	104
USB flash drive.....	80
USB In interface.....	37
USB interfaces.....	36, 41, 45
User serial ID.....	73

V

Vibration.....	29, 29
Video signal.....	34, 40, 44
Viewing angles.....	110

W

Wiring.....	65
-------------	----